

# **LOKRING® ALUMINIUM CONNECTORS TYPE 50**

TECHNICAL DOCUMENTATION & SUBMITTAL VERSION 1.7

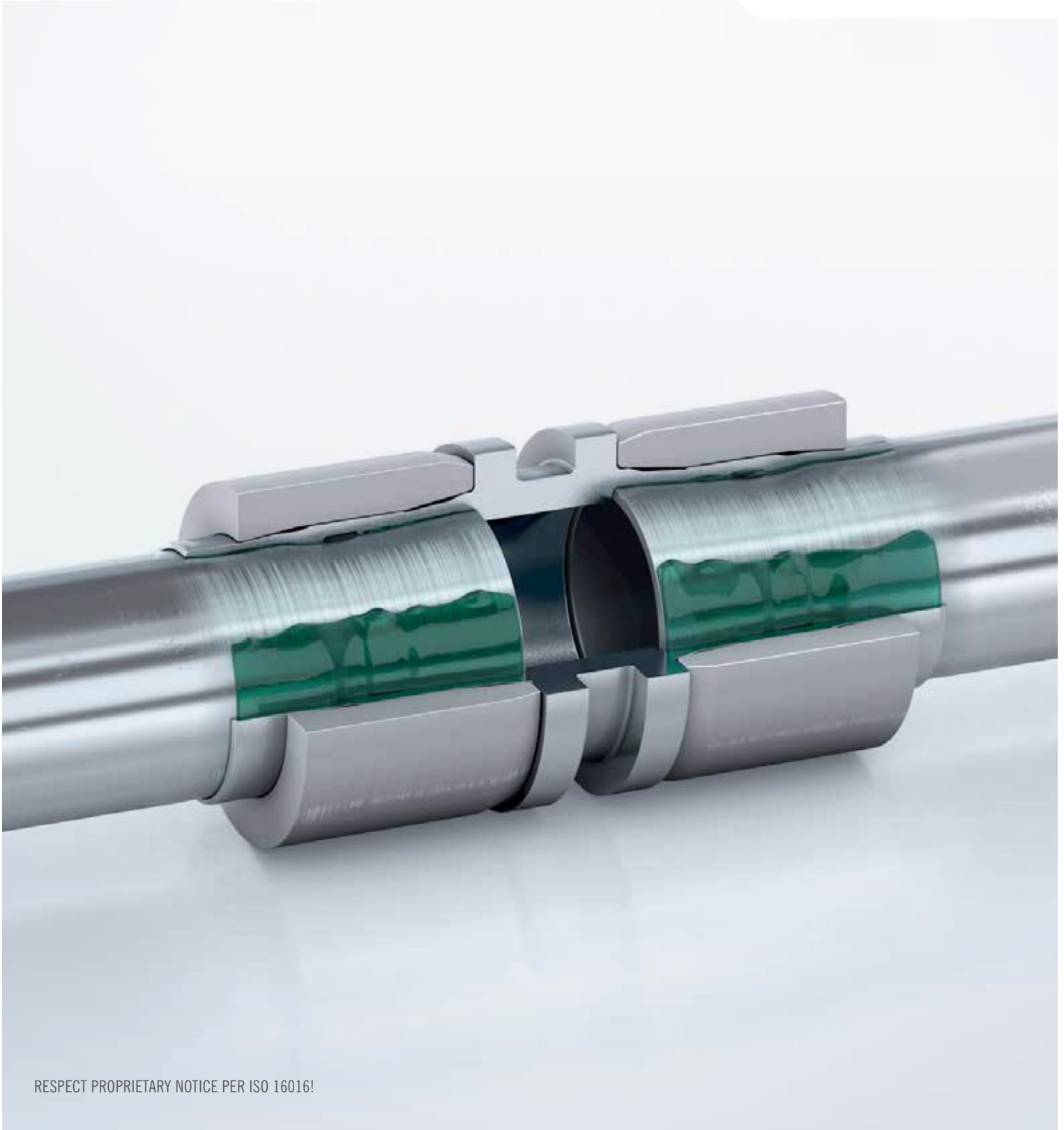



---

# CONTENT

---

1.0	INTRODUCTION	03
2.0	AREAS OF APPLICATION	03
3.0	COMPONENTS OF A LOKRING® CONNECTION	03
4.0	FUNCTIONAL PRINCIPLE	04
5.0	LOKPREP (ANAEROBIC SEALANT)	04
5.1	SPREADING THE LOKPREP	05
5.2	CURING TIME	05
6.0	TECHNICAL SPECIFICATIONS AND APPROVALS OF THE LOKRING CONNECTION	06
7.0	MATERIAL COMBINATIONS	06
8.0	CONNECTIONS FROM ALUMINIUM TO COPPER TUBE	06
9.0	ALUMINIUM TUBE SPECIFICATION / ALUMINIUM STABILISATION INSERT (LOKRING VH AL)	07
10.0	STRAIGHT ALUMINIUM CONNECTOR (LOKRING NK AL 50)	08
11.0	STRAIGHT ALUMINIUM REDUCING CONNECTOR (LOKRING NR AL 50)	09
12.0	ALUMINIUM FLARE NUTS (LOKRING FN AL)	10
13.0	DECLARATION REGARDING PASSED TESTS ACCORDING EN 16084:2011	11
	ASSEMBLY INSTRUCTIONS	12
	ONLINE-SERVICE	14
	VALIDITY CLAUSE	15

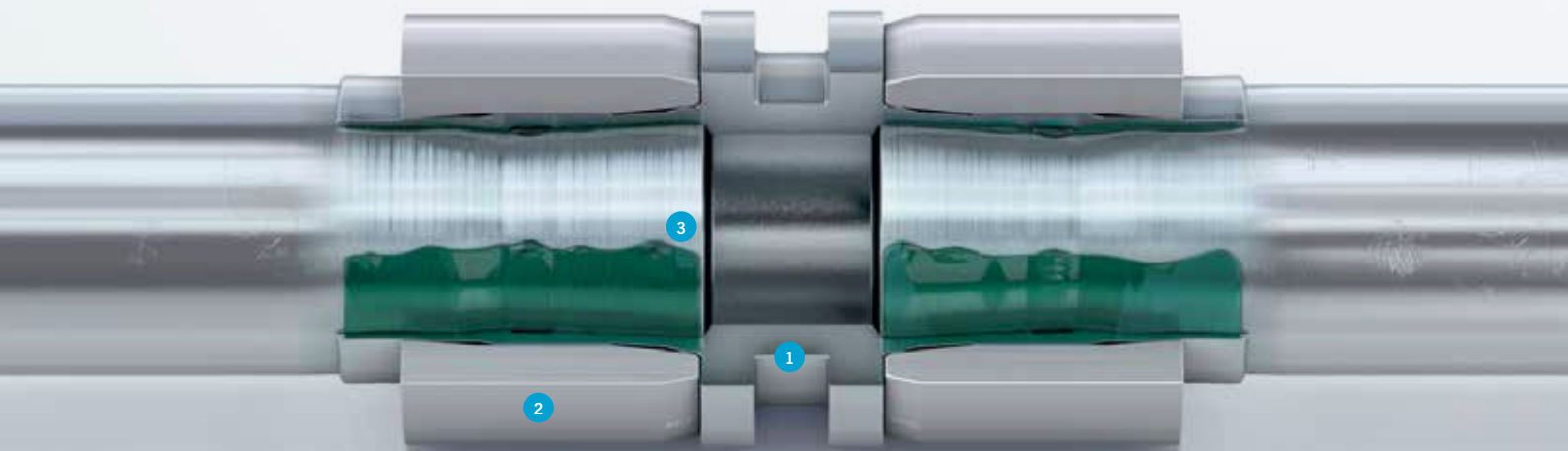

# LOKRING® ALUMINIUM CONNECTORS TYPE 50

## 1.0 INTRODUCTION

The purpose of this document is to give technicians all information necessary about the solder-free LOKRING® tube connection technology in general and especially about aluminium LOKRING® connectors type 50 for use in refrigeration and air conditioning technology.

## 2.0 AREAS OF APPLICATION

### LOKRING® ALUMINIUM CONNECTORS TYPE 50 ARE BEING USED IN:

- ⊕ Refrigeration and Air conditioning Technology
- ⊕ Air conditioning systems (split, multi-split, vehicles)
- ⊕ Commercial product refrigeration
- ⊕ Heat pumps
- ⊕ Solar thermal energy
- ⊕ Geothermal energy

## 3.0 COMPONENTS OF A LOKRING® CONNECTION



### JOINT (1)

The shape of the aluminium joint to be used is defined by one of the many types, sizes and repair situations.

### RING (2)

Up to a diameter of 12 mm, the rings are pre-assembled on the joint when delivered.



### STABILISATION INSERT (3)

Aluminium stabilisation inserts bring additional safety into the LOKRING® connection by increasing the necessary pull-out force. They also help correct slight ovality found in coiled line sets. Stabilisation inserts must always be used for LOKRING® aluminium connections type 50 when the operating exceeds 25 bar (360 psi).



### LOKPREP (4)

LOKPREP is an important component of the LOKRING® connection technology. LOKPREP will compensate for any unevenness in the tube surface such as longitudinal grooves or surface porosity, thus ensuring that every LOKRING® connection is hermetically sealed.



### LOKTOOL MZ-V (5)

The hand assembly tool reduces the manual force needed during assembly. The assembly jaws are easy to exchange to match the size of the LOKRING® to be fitted.



### LOKTOOL MB (6)

The assembly jaws fit the hand assembly tools LOKTOOL MZ and MZ-V. They can be replaced quickly and easily, thus making LOKRING® assembly possible with only one tool for different tube diameters.

# LOKRING® ALUMINIUM CONNECTORS TYPE 50

## 4.0 FUNCTIONAL PRINCIPLE

The LOKRING® tube connection works on the basis of »simple« physical laws. It consists of two rings and one tubular joint which takes the two tube ends. During assembly, the tube ends are inserted into the joint to the inner limit. Then an assembly tool is used to push the two rings axially onto the joint. Due to the conical inner contour of the rings and the special outer and inner contour of the joint, the diameter of the joint is reduced during assembly so that the tube and the joint form a metallic hermetic connection through surface contact.

The lifetime air-tightness of the fitted connection is ensured by the state of permanent elastic pre-tension, which is produced by the balance of the radial forces acting in opposite directions from tube to ring.



## 5.0 LOKPREP (ANAEROBIC SEALANT)

Metal tubes can have longitudinal grooves on the surface from production. These production related faults can be compensated quite easily by moistening the tube ends to be connected with LOKPREP fluid before assembly. Thanks to its capillary characteristic, it can even flow into microscopic cavities and fill these out completely.

LOKPREP is not an adhesive, rather an anaerobic sealant which hardens under oxygen exclusion and in contact with free metal ions. Its elastic structure is permanently retained in a temperature range of -50 to 150°C (-58°F to 302°F), thus compensating material-specific deformations due to fluctuations in temperature. Since LOKPREP does not contain solvents which have to evaporate during hardening, the finished connection is ready for use shortly after assembly.

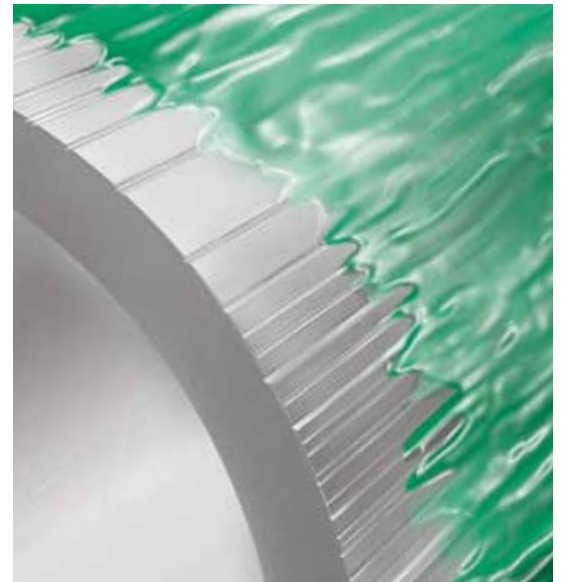

### 5.1 SPREADING THE LOKPREP

Check the expiry date before applying LOKPREP. Always make sure that the whole tube circumference is moistened with LOKPREP.

**POSSIBILITY A**

Rotate the moistened tube through 360° inside the joint.

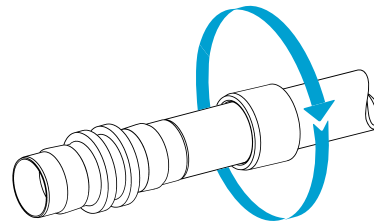

**POSSIBILITY B**

Rotate the joint through 360° around the end of the tube.

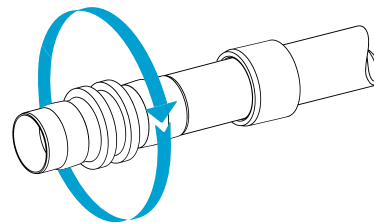

**POSSIBILITY C**

Move the nozzle 360° around the tube to distribute the LOKPREP evenly.

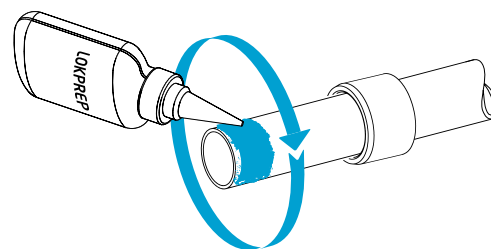

### 5.2 CURING TIME

Always make sure that the LOKPREP is properly cured before exerting any force on the LOKRING connection by moving, turning or bending the tube.

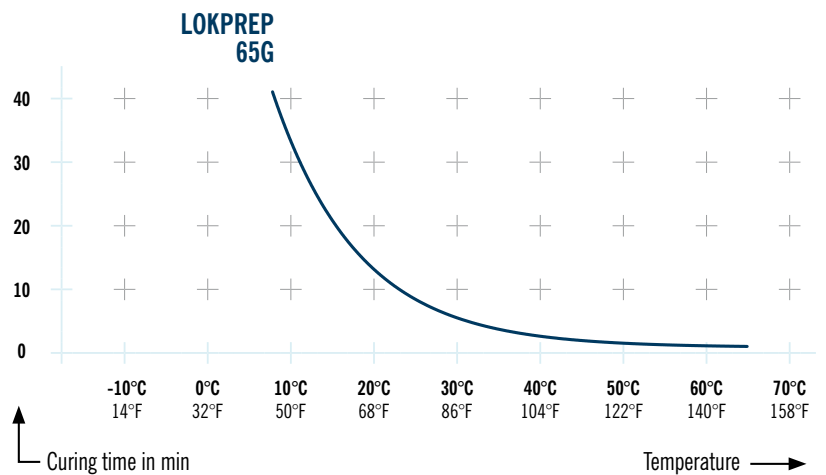

**6.0 TECHNICAL SPECIFICATIONS AND APPROVALS OF THE LOKRING CONNECTION**

**Reference standards:** EN 378-2 and ISO 14903  
**Max. operating pressure:** 50 bar (725 psi)  
**Admissible refrigerants:** Suitable for all HFCs and mixtures, all HC's, R32 and HFO-1234yf. Not suitable for NH<sub>3</sub>.  
**Temperature range:** -50°C up to 150°C (-58°F up to 302°F)  
**Tube diameter range:** 6.35 to 22.23 mm (1/4" to 7/8")  
**Minimum tube wall thickness:** 0.8 mm  
**Approvals:** TÜV, UL (File SA12004)

**7.0 MATERIAL COMBINATIONS\***



\* Other material combinations on request.

**8.0 CONNECTIONS FROM ALUMINIUM TO COPPER TUBE**

For connections from aluminium to copper a heat shrink sleeve must be used to protect the connection against contact corrosion.



Inside the copper tube a brass stabilisation insert has to be used.



**NOTE:**  
 For both, the aluminium tube and the copper tube LOKPREP 65G has to be used.





# ALUMINIUM TUBE SPECIFICATION / ALUMINIUM STABILISATION INSERT

## 9.0 ALUMINIUM TUBE SPECIFICATION / ALUMINIUM STABILISATION INSERT (LOKRING VH AL)

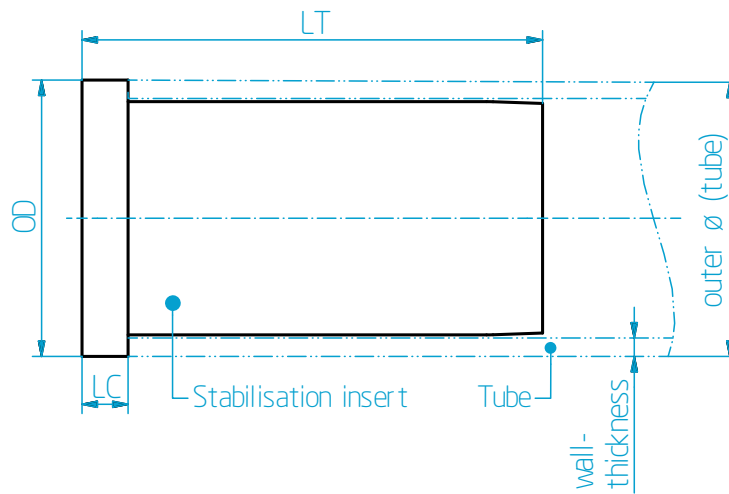

Article no.	Article name	Dimensions						
		max. tube outer-ø	min. tube outer-ø	max. wall thickness	min. wall thickness	LC	OD	LT
		mm	mm	mm	mm	mm	mm	mm
L13005456	LOKRING 6.35 VH AI 08	6.40	6.30	0.88	0.72	2	6.35	14.5
L13005482	LOKRING 6.35 VH AI 10	6.40	6.30	1.10	0.90	2	6.35	14.5
L13005457	LOKRING 8 VH AI 08	8.05	7.89	0.88	0.72	2	8	15.5
L13005483	LOKRING 8 VH AI 10	8.05	7.89	1.10	0.90	2	8	15.5
L13005458	LOKRING 9.53 VH AI 08	9.05	8.95	0.88	0.72	2	9	16.5
L13005484	LOKRING 9.53 VH AI 10	9.05	8.95	1.10	0.90	2	9	16.5
L13005574	LOKRING 10 VH AI 10	10.05	9.95	1.10	0.90	2	10	16.5
L13005459	LOKRING 12.7 VH AI 08	12.75	12.65	0.88	0.72	2.5	12	17.5
L13005485	LOKRING 12.7 VH AI 10	12.75	12.65	1.10	0.90	2.5	12	17.5
L13005577	LOKRING 12.7 VH AI 12	12.75	12.65	1.32	1.08	2.5	12	17.5
L13005575	LOKRING 15 VH AI 10	15.05	14.95	1.10	0.90	2.5	15	19.5
L13005460	LOKRING 16 VH AI 10	16.05	15.83	1.10	0.90	2.5	15	19.5
L13005578	LOKRING 16 VH AI 12	16.05	15.83	1.32	1.08	2.5	15	19.5
L13005580	LOKRING 16 VH AI 15	16.05	15.83	1.65	1.35	2.5	15	19.5
L13005576	LOKRING 18 VH AI 10	18.05	17.95	1.10	0.90	2.5	18	20.5
L13005461	LOKRING 19 VH AI 10	19.11	18.99	1.10	0.90	2.5	19	21.5
L13005700	LOKRING 19 VH AI 12	19.11	18.99	1.32	1.08	2.5	19	21.5
L13005579	LOKRING 19 VH AI 15	19.11	18.99	1.65	1.35	2.5	19	21.5
L13005462	LOKRING 22 VH AI 12	22.29	21.94	1.32	1.08	2.5	22	25

# STRAIGHT ALUMINIUM CONNECTOR

## 10.0 STRAIGHT ALUMINIUM CONNECTOR (LOKRING NK AL 50)

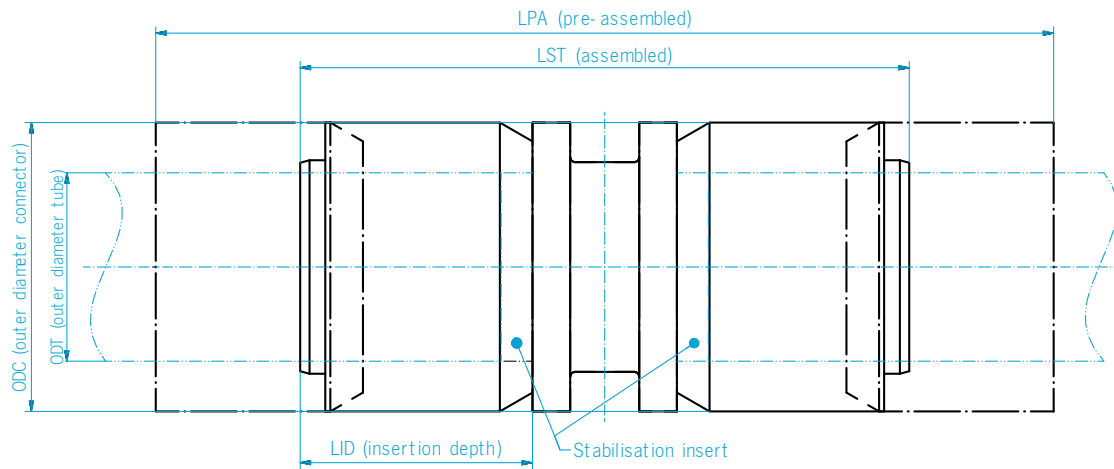

Article no.	Article name	Dimension						Notes
		ODT		ODC	LID	LST	LPA (approx.)	
		mm	in	mm	mm	mm	mm	
L13005444	LOKRING 6.35 NK Al 50	6.35	1/4	13	13,5	36.5	48	
L13005445	LOKRING 8 NK Al 50	8	5/16	14	15	39.5	51	
L13005446	LOKRING 9.53 NK Al 50	9.53	3/8	16	16	41.5	55	
L13005502	LOKRING 10 NK Al 50	10	-	16	16	41.5	55	
L13005447	LOKRING 12.7 NK Al 50	12.7	1/2	19	17	44	57	
L13005564	LOKRING 15 NK Al 50	15	-	22	18	47.5	65	
L13005448	LOKRING 16 NK Al 50	16	5/8	22	18	47.5	65	
L13005501	LOKRING 18 NK Al 50	18	-	26	19	50.5	70	
L13005449	LOKRING 19 NK Al 50	19.05	3/4	26	20	52.5	73	
L13005450	LOKRING 22 NK Al 50	22	7/8	30	22	56.5	80	

# STRAIGHT ALUMINIUM REDUCING CONNECTOR

## 11.0 STRAIGHT ALUMINIUM REDUCING CONNECTOR (LOKRING NR AL 50)

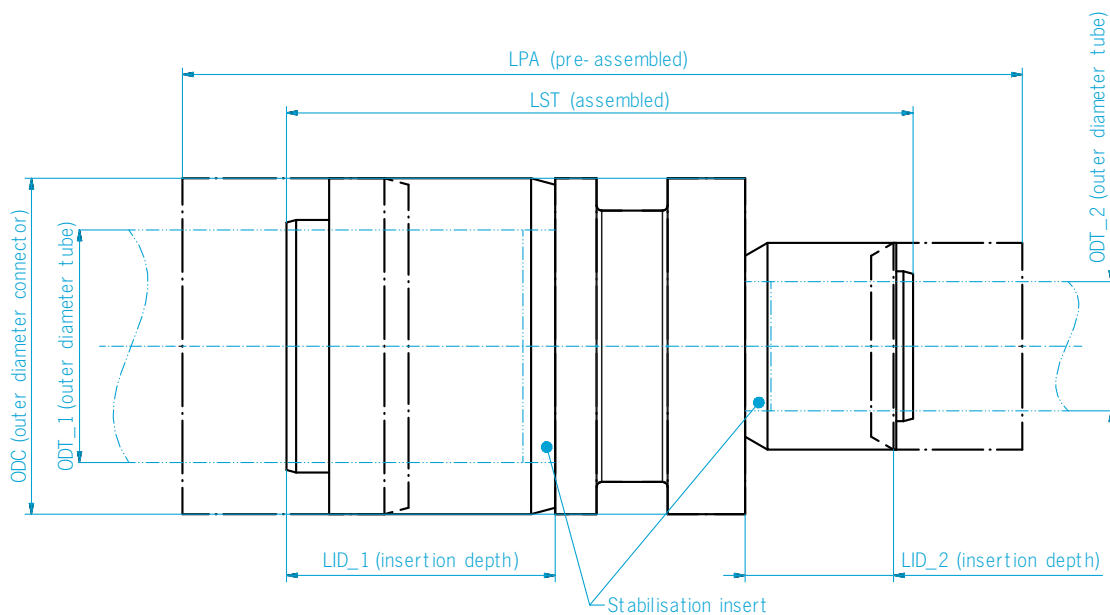

Article no.	Article name	Dimension									Notes
		ODT1		ODT2		ODC	LID_1	LID_2	LST	LPA (approx.)	
		mm   in	mm   in	mm   in	mm	mm	mm	mm			
L13005451	LOKRING 9,53/6,35 NR Al 50	9.53	3/8	6.35	1/4	16	16	13.5	39	51	
L13005664	LOKRING 9,53/8 NR Al 50	9.53	3/8	8	5/16	16	16	15	40.5	52.5	
L13005668	LOKRING 10/9,53 NR Al 50	10	-	9.53	3/8	16	16	16	41.5	54.5	
L13005452	LOKRING 12,7/9,53 NR Al 50	12.7	1/2	9.53	3/8	19	17	16	43	56	
L13005453	LOKRING 16/12,7 NR Al 50	16	5/8	12.7	1/2	22	18	17	46.5	61.5	
L13005663	LOKRING 16/15 NR Al 50	16	5/8	15	-	22	18	18	47.5	65.5	
L13005454	LOKRING 19/16 NR Al 50	19.05	3/4	16	5/8	26	20	18	50.5	69	
L13005671	LOKRING 19/18 NR Al 50	19.05	3/4	18	-	26	20	19	51.5	71	
L13005455	LOKRING 22/19 NR Al 50	22	7/8	19.05	3/4	30	22	20	54.5	76	

# ALUMINIUM FLARE NUTS

## 12.0 ALUMINIUM FLARE NUTS (LOKRING FN AL)

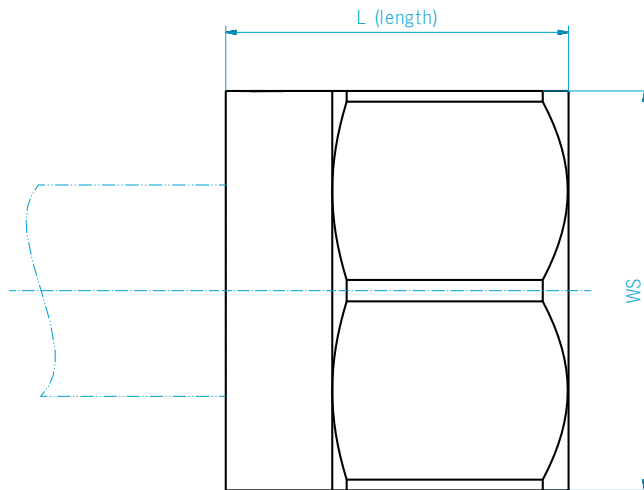

**Do not use EURO flare-fittings type LOKRING LR-EURO-EB with aluminium LOKRING connectors.**

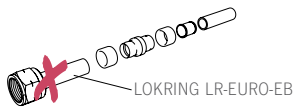

Article no.	Article name	Dimension					Notes	
		ODT	LAN (ca.)	WS (Nut)	Thread (Nut)	Tightening torque		
		mm   in	mm	mm	in	(Nm)		
L13005463	LOKRING AI FN 6,35	6.35	1/4	15,5	17	1/4 SAE	20	All connections of aluminium nuts with threaded connections made from a different material than aluminium have to be protected against contact corrosion.
L13005464	LOKRING AI FN 9,53	9.53	3/8	17,5	22	3/8 SAE	30	
L13005465	LOKRING AI FN 12,7	12.7	1/2	20,6	24	1/2 SAE	40	
L13005466	LOKRING AI FN 16	16	5/8	23,9	27	5/8 SAE	50	
L13005467	LOKRING AI FN 19	19.05	3/4	32	36	3/4 SAE	60	

# DECLARATION REGARDING PASSED TESTS

## 13.0 DECLARATION REGARDING PASSED TESTS

**VULKAN**

**VULKAN  
LOKRING**

### Declaration regarding passed Tests according EN 16084:2011 (meanwhile replaced by ISO 14903:2017)

In the time frame of: July to September 2013  
tests on tube joints according EN 16084:2011 have been performed at or on behalf of:

VULKAN Lokring  
Rohrverbindungen GmbH & Co. KG  
Heerstraße 66  
44653 Herne, Deutschland

> The joints consisted of: aluminium tube of following sizes:  
ø6.35 x 0.8 mm; ø9.53 x 0.8 mm;  
ø15.88 x 1 mm; ø22.23 x 1.25 mm.

joined by: LOKRING aluminium connectors of appropriate size for applications up to 50 bar operating pressure

> using: LOKPREP 65G

The test-plan according to the standard includes:  
Tightness-test, preparatory  
Vacuum-test\*  
Pressure-temperature-test\*\*  
Vibration-test  
Freezing-test  
Pressure-test  
Fatigue-test  
Tightness-test, terminatory

> \*The procedure of the vacuum-test according to the parameters of the standard is controversial. Corresponding comments have been given to the standardization organization and have been confirmed by a member of the corresponding workgroup. A revision of the standard is planned. Due to this the vacuum-test is omitted until further notice.

\*\*The pressure-temperature test already was performed 2012 at an external laboratory. However, the related tightness tests before and after the test have been made within Vulkan Lokring.

VULKAN Lokring Rohrverbindungen GmbH & Co.KG assures that all test are performed carefully and according the actual interpretation of the standard and that the involved equipment is adequate for the performed tests.

The tested samples after running through the load tests have met the requirements of tightness control level A1 (hermetic joints, max.  $7.5 \cdot 10^{-6}$  mbar-l/s Helium at 10 bar and 20°C).

16.06.2014, Thome  
Date Development Manager



# ASSEMBLY INSTRUCTIONS

## LOKRING® tube connection assembly version 50

(The assembly version is determined on the basis of the last two figures in the article name. Example: LOKRING 6 NK Ms 50)

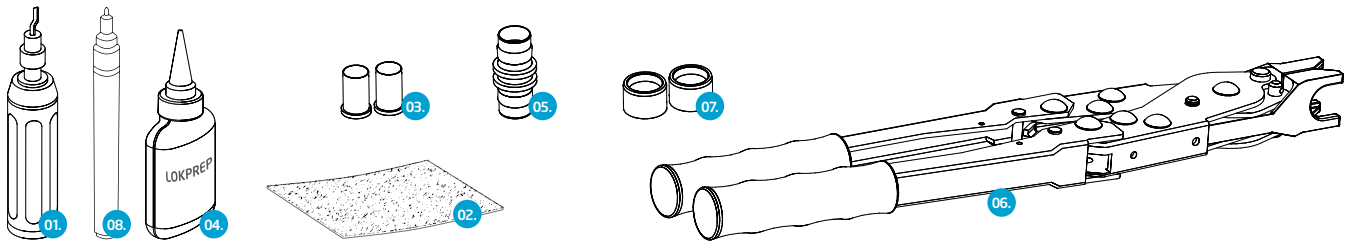

01. Tube deburrer 02. Abrasive mat 03. Stabilisation inserts 04. LOKPREP 05. Joint 06. Hand assembly tool 07. LOKRINGs 08. Permanent marker



Deburr the tube end all the way round using a tube deburrer (01). Use different deburring tools for different materials.

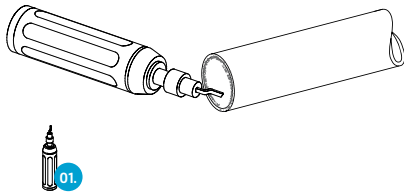

Clean the tube end by rubbing it in rotary movements using the abrasive mat (02).

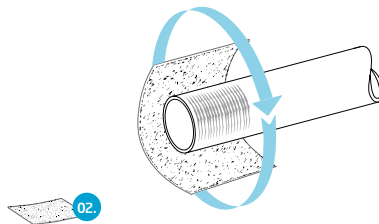

Determine the tube wall thickness  $S$  and the outer tube diameter  $\emptyset$  on the basis of tube coding or using a slide gauge.

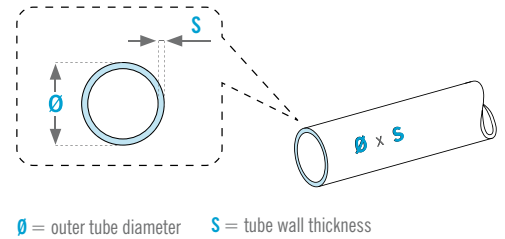

1

Insert a stabilisation insert (03) suitable for the material, the outer tube diameter  $\emptyset$  and tube wall thickness  $S$ . Stabilisation inserts may not be necessary in case of use with refrigerants with an operating pressure lower than 25 bar (e.g. R134a car A/C systems or refrigerator cabinets).

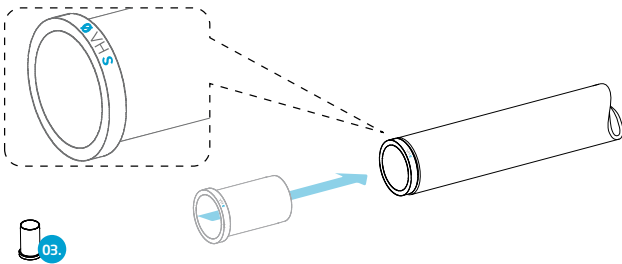

2

Before applying the LOKPREP (04), push the connecting joint onto the tube until you can feel the inner stop. Mark (08) the correct insertion depth on the tube.

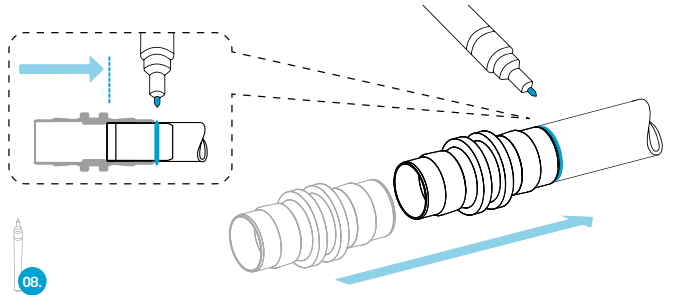

3

Choose the correct LOKPREP for the tube material and the ambient temperature. Apply LOKPREP (04) all the way round the sealing area of the tube end. Respect the correct curing time of the LOKPREP.

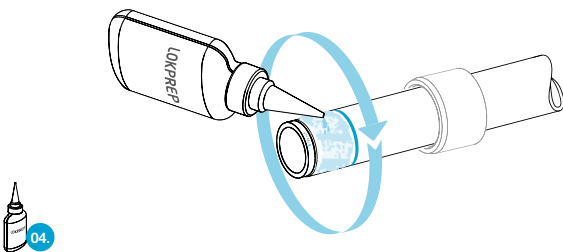

4

Push the connection joint (05) onto the tube until it reaches the inner stop **!**

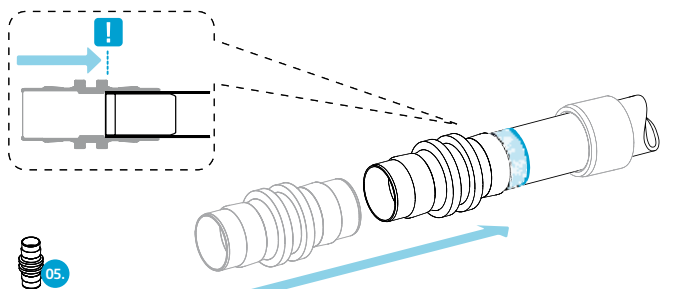

5

Put the assembly jaws (06) in place behind the LOKRING (07) and the assembly stop of the joint (05). Press the tube connection together. **!** Do not change the insertion depth of the tube and connecting joint. Press the tube connection until the LOKRING (07) is flush to the assembly stop of the joint (05).

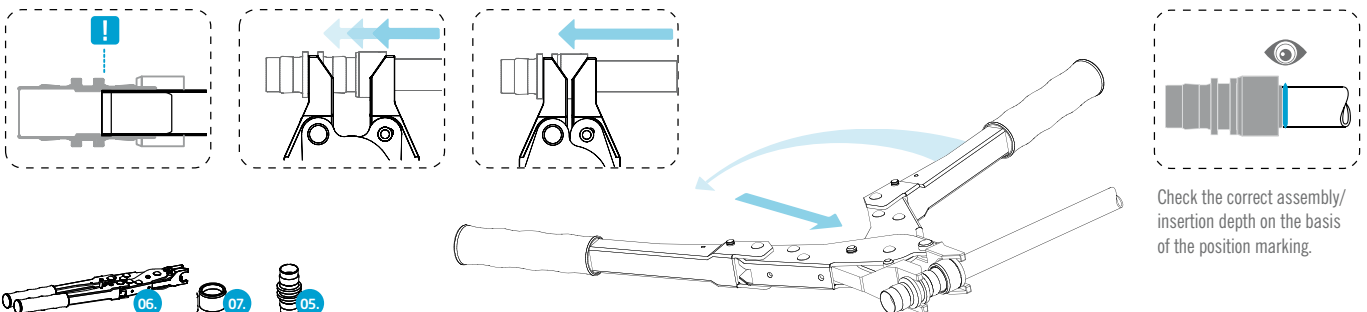

## CHOOSING THE STABILISATION INSERT

LOKRING® tube connection assembly version 50

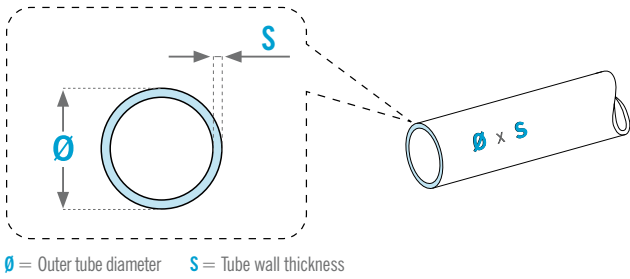

Article name                      Stabilisation insert                      Tube wall thickness in mm (S)

**LOKIN 6,35 VH Ms 08**

Outer tube diameter (Ø)                      Tube material  
 Ms for brass\* or Al for aluminium\*

\* Use Ms stabilisation inserts for copper tube and Al stabilisation inserts for aluminium tube.

**Note:** Stabilisation inserts must not be used inside an NRA adaptor or inside the stainless steel tube of a EURO flare-fitting.

## CHOOSING THE LOKPREP

LOKRING® tube connection assembly version 50

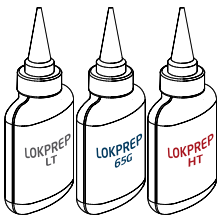

- Use an **aluminium LOKRING® connector** and **LOKPREP 65G** for all connections from aluminium to aluminium or aluminium to copper. Always use a heat shrink sleeve for connections from aluminium to copper in order to protect the connection against corrosion.
- Use a **brass LOKRING® connector** and **LOKPREP LT** or **LOKPREP HT** for all connections from copper to copper.

**!** The following diagram shows the suitable temperature ranges for LOKPREP LT and LOKPREP HT.

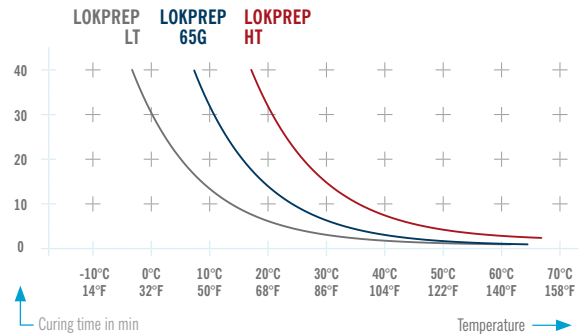
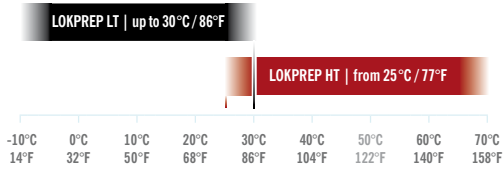

## EXAMPLES AS ASSEMBLY AID

LOKRING® tube connection assembly version 50

**!** **Wrong:** LOKRING has not been pressed through to the assembly stop.      **Right:** LOKRING has been pressed flush to the assembly stop.

**!** **Wrong:** Stabilisation insert is missing.      **Right:** Correct stabilisation insert is inserted.

**!** **Wrong:** Assembly jaws are not set in place correctly.      **Right:** Assembly jaws are set flush correctly.

**!** **Wrong:** The tube is not pushed in as far as the inner stop.      **Right:** Push the tube in until you can feel the inner stop.

# ONLINE-SERVICE

FOR FURTHER INFORMATION, PLEASE REFER TO OUR WEBSITE [WWW.VULKAN.COM](http://WWW.VULKAN.COM).



## AUTHORISED DISTRIBUTORS

[www.vulkan.com/en-us/lokring/contact/](http://www.vulkan.com/en-us/lokring/contact/)



## VIDEOS

[www.vulkan.com/en-us/lokring/videos/](http://www.vulkan.com/en-us/lokring/videos/)



## TECHNICAL DOCUMENTATION AND SUBMITTAL

[www.vulkan.com/en-us/lokring/downloads/technical-documentation-and-submittal](http://www.vulkan.com/en-us/lokring/downloads/technical-documentation-and-submittal)



## CATALOGUES & BROCHURES

[www.vulkan.com/en-us/lokring/downloads/](http://www.vulkan.com/en-us/lokring/downloads/)



## CERTIFICATES

[www.vulkan.com/en-us/lokring/downloads/certificates/](http://www.vulkan.com/en-us/lokring/downloads/certificates/)



# IMPRINT

**PUBLISHER:**

VULKAN Lokring Rohrverbindungen GmbH & Co. KG  
Heerstraße 66, 44653 Herne / Germany  
Tel.: + 49 (23 25) 922-155  
Fax: + 49 (23 25) 51222  
E-mail: info.lok@vulkan.com

**CONCEPT AND DESIGN:**

Hackforth Holding GmbH & Co. KG  
VULKAN Marketing  
Heerstraße 66, 44653 Herne / Germany  
E-mail: marketing@vulkan.com

**PREPRESS:**

Hackforth Holding GmbH & Co. KG  
VULKAN Marketing  
Heerstraße 66, 44653 Herne / Germany  
E-mail: marketing@vulkan.com

**VALIDITY CLAUSE**

The LOKRING® tube connection technology represents a proven method of producing hermetically sealed metal-to-metal tube connections. The LOKRING® tube connections are mainly used in the refrigeration and air conditioning industries. The use of LOKRING® tube connection technology in other fields is to be discussed with VULKAN Lokring. VULKAN Lokring as the supplier is responsible for the qualitative delivery of the tube connections and tools which are ordered.

The purchaser is responsible for the use of the LOKRING® tube connections and tools as directed. The assembly has to be done accordingly to the instructions and exclusively with original LOKRING® parts. The present submittal shall replace all previous editions. The data contained in this submittal refers to the valid state of affairs in time of the copy deadline. Any changes due to technical progress are reserved.

**Status:** 09/2020

All duplication, reprinting and translation rights are reserved. Further remarks for the LOKRING® assembly are available on request.



[www.vulkan.com/en-us/lokring/videos/](http://www.vulkan.com/en-us/lokring/videos/)