

We ensure that systems work better.

VULKAN

Solutions for refrigeration and air conditioning technology

Service Equipment

For servicing refrigeration
and air conditioning systems



CONTENTS

02	LEAK DETECTION
14	RECOVERY, EVACUATION, CHARGING
26	QUICK-COUPERS
30	REFRIGERANTS
32	MEASUREMENT AND DIAGNOSTIC DEVICES
36	FITTINGS
38	COMPRESSORS
40	USEFUL ACCESSORIES
44	ONLINE-SERVICE
45	IMPRINT

LEAK DETECTION

TRACE GAS LEAK DETECTION

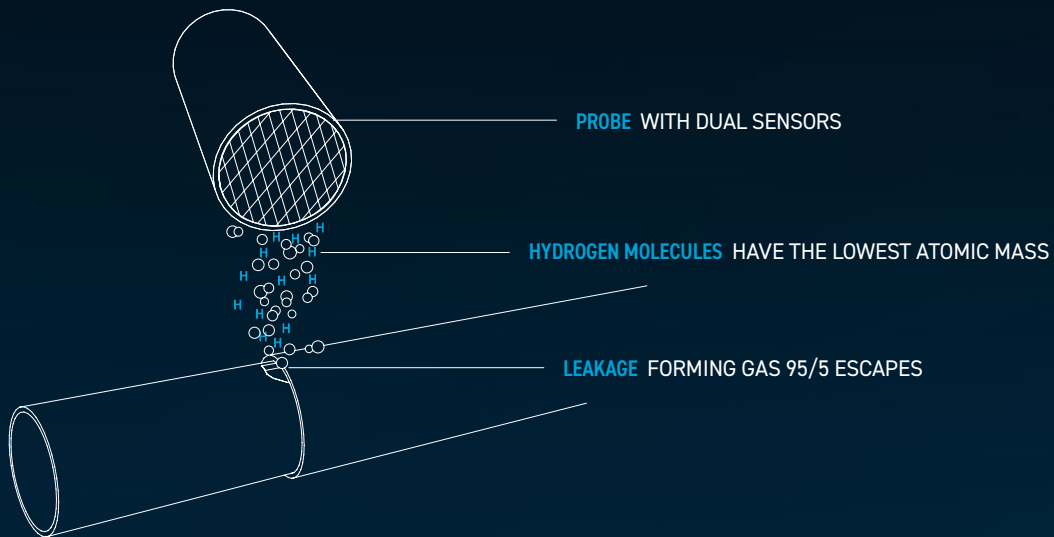

[PAGE 04](#) MULTI GAS LEAK DETECTOR

[PAGE 08](#) HYDROGEN LEAK DETECTOR

[PAGE 10](#) TRACE GAS LEAK DETECTION KITS

[PAGE 12](#) REFRIGERANT LEAK DETECTOR

[PAGE 13](#) NITROGEN PRESSURE TESTING

FIND THE LEAK!

THE LEAK DETECTION TECHNOLOGY DEVELOPED FOR THE INDUSTRY IS PERFECTLY TAILORED TO SERVICING APPLICATIONS, AND THEREFORE GUARANTEES LEGALLY COMPLIANT, FAST, RELIABLE AND SIMPLE LEAK DETECTION.

FOR LEAK DETECTION, the empty air conditioning system is charged with forming gas 95/5 consisting of 95 percent nitrogen and 5 percent hydrogen. Forming gas 95/5 is non-flammable, non-toxic, non-corrosive and not harmful to the environment. Hydrogen molecules have the smallest atomic mass of all the elements and can escape due to even

the smallest leak. With the aid of hydrogen leak detectors LOKTRACER TLD.500 and LOKTRACER TLD.1000, very small leakages can therefore be detected. The leak detectors react almost exclusively to hydrogen. There are therefore hardly any cross sensitivities.

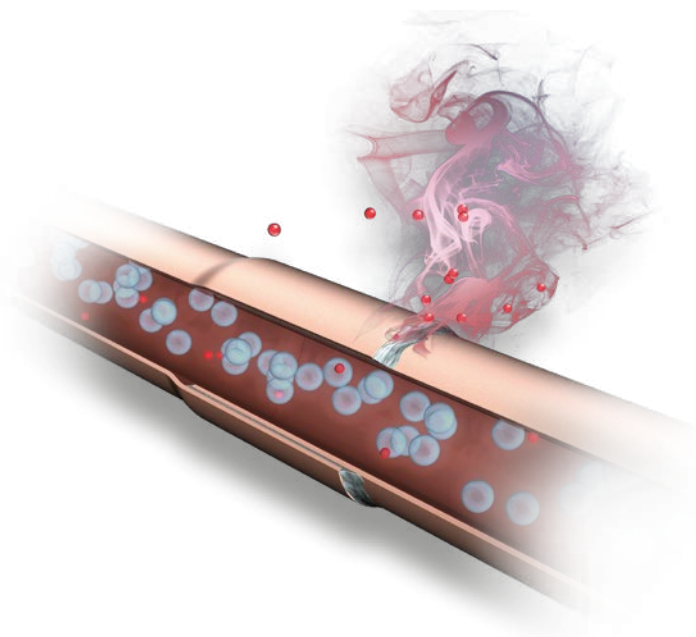

LOKTRACE IN COMPARISON TO CONVENTIONAL LEAK DETECTION METHODS

	LOKTRACE	UV dye	Electronic refrigerant leak detectors	Nitrogen and leak detection spray
Compliance with legal requirements	✓	✗	✗	✓
Direct operability	✓	✗	✓	✓
Detects the smallest leakages	✓	✗	✓	✗
Reliability	✓	✓	✗	✓

MULTI GAS LEAK DETECTOR

MULTI GAS LEAK DETECTOR FOR INDUSTRIAL LEAK DETECTION (HFC, HFO, R32, R600a, R290, H₂ TRACER GAS)



Mobile, industrial leak detector. The high flexibility of the LOKATOR VL20 allows for use with different refrigerants and for H₂ tracer gas with the same probe. The unit is the perfect tool for quick and accurate leak location whatever the gas to be detected.

The simple and easy to use LOKATOR VL20 is designed for small or medium size production lines of refrigeration and A/C units. Its main advantage is to very quickly find even fine leaks. The operator can set two alarm levels or select one manually. The unit gives a clear visual and audible alarm indication as soon as the leak level is exceeded. Maintenance can be done easily on-site within a few seconds.

- ⊕ Shock-proof housing.
- ⊕ Intuitive interface on a 4 line LCD.
- ⊕ Easy maintenance and calibration.
- ⊕ Visual indication of leaks, degassing, saturation and ambient contamination.
- ⊕ Permanent self-checking of power supply, probes and connections.
- ⊕ Automatic zeroing with compensation of ambient contamination.
- ⊕ Audible indication of leaks.

NOTE: The base unit comes without probe and without probe cable. Please select those articles from the following tables.

Article no.	Article name	Description
L14004337	LOKATOR VL20-BU	Base unit

Technical data

Warm-up time:	180 sec.
Reaction time:	1 sec.
Operating temperature:	10 °C - 40 °C
Power supply:	Rechargeable battery (9 V - 1.5 A max.)
Battery life:	4 hours
L x H x D in mm:	220 x 220 x 80
Weight:	550 g

PROBE



- ⊕ Suitable for HFC, HFO, R600a, R290, H₂ tracer gas.
- ⊕ Plug and play.
- ⊕ Red LED indicates a leak.
- ⊕ Probe consists of detection block with universal sensor and sniffing pipe.

Article no.	Article name	Description
L14004341	LOKATOR VL20-CSU-U	Universal probe

Technical data

Sensitivity:	0.5 g/yr for HFC and HFO 0.5 g /yr for R600a and R290 1x10 ⁻⁵ cc/s for H ₂ /N ₂ or 1 g/yr R134a equivalent
Sniffing pipe:	Flexible (130 mm)

Also available separately

Article no.	Article name	Description
L14004343	LOKATOR VL20-DB-U	Detection block with universal sensor
L14004344	LOKATOR VL20-SP13	Sniffing pipe



PROBE CABLE



Cable for connecting the base unit to the probe.

Article no.	Article name	Description
L14004342	LOKATOR VL20-C2P6B-2.5M	Probe cable (2.5 m)

MULTI GAS LEAK DETECTOR

MULTI GAS LEAK DETECTOR FOR INDUSTRIAL LEAK DETECTION (HFC, HFO, R32, R600a, R290, H₂ TRACER GAS)



Efficient and robust industrial leak detector with intuitive user interface suitable for refrigerant gases and H₂ tracer gas. The base unit can be equipped with different probes and cables to perfectly match your application.

The LOKATOR VL30 is designed for quick and highly accurate leak detection on high-productivity production lines, such as manufacturing of domestic refrigerators, heat pumps or A/C split units. The unit gives a clear indication of the leak size and it allows an easy maintenance on-site within a few seconds.

- ⊕ Shock-proof housing.
- ⊕ Intuitive interface on a 4 line LCD.
- ⊕ Easy maintenance and calibration.
- ⊕ Visual indication of leaks, degassing, saturation and ambient contamination.
- ⊕ Permanent self-checking of power supply, probes and connections.
- ⊕ Automatic zeroing with compensation of ambient contamination.
- ⊕ Audible indication of leaks with adjustable volume.

NOTE: The base unit comes without probe and without probe cable. Please select those articles from the following tables.

Article no.	Article name	Description
L14004338	LOKATOR VL30-BU	Base unit

Technical data

Warm-up time:	180 sec.
Reaction time:	1 sec.
Operating temperature:	10 °C – 40 °C
Interface DB9:	Logical signal output 0 V – 5 V
Power supply:	110 V-250 V, 50/60 Hz
Power consumption:	50 W
L x H x D in mm:	300 x 150 x 200
Weight:	Approx. 3.5 kg



REFRIGERANT PROBE / HYDROGEN PROBE



- ⊕ Selective (only hydrogen probe).
- ⊕ Plug and play.
- ⊕ Red LED indicates a leak.
- ⊕ Probe consists of suction block, sniffing pipe and sensor cell.

Article no.	Article name	Description
L14004346	LOKATOR VL30-CSU-REF ①	Refrigerant probe
L14004311	LOKATOR VL30-CSU-H2 ②	Hydrogen probe

Technical data

Sensitivity (refrigerant probe):	0.5 g/yr for R290, HFC, HFO and 0.05 g/yr for R600a
Sensitivity (hydrogen probe):	3x10 ⁻⁶ cc/s or 0.3 g/yr R134a equivalent
Sniffing pipe:	Semi rigid (150 mm)

Also available separately

Article no.	Article name	Description
L14004332	LOKATOR VL30-SB	Suction block
L14004348	LOKATOR VL30-SRSP13	Sniffing pipe
L14004334	LOKATOR VL30-C-REF	Refrigerant sensor cell
L14004333	LOKATOR VL30-C-H2	Hydrogen sensor cell

PROBE CABLE



Cable for connecting the base unit to the probe.

Article no.	Article name	Description
L14004336	LOKATOR VL30-C2P6B-2.5M	Probe cable (2.5 m)
L14004347	LOKATOR VL30-C2P6B-5M	Probe cable (5 m)

HYDROGEN LEAK DETECTOR

HYDROGEN LEAK DETECTOR



- ⊕ Developed especially for refrigeration and air conditioning technology.
- ⊕ Made in Germany.
- ⊕ Effective hydrogen leak detector thanks to unique dual sensors.
- ⊕ Very low cross sensitivity to external gases.
- ⊕ Incremental approximation of major leaks (zero tracking).
- ⊕ Automatic sensor cleaning.
- ⊕ No pump or filter due to diffusion technology.
- ⊕ Integrated LED light.
- ⊕ Acoustic and optical alarm.

Article no.	Article name
L13005099	LOKTRACER TLD.500

Technical data	
Time to operability:	< 60 s
Reaction time:	1 to 2 s
Operating time:	Approx. 5 h
Power supply:	Rechargeable batteries

Also available separately		
Article no.	Article name	Description
L14004043	PA-TLD.500	Mains charger

HYDROGEN LEAK DETECTOR WITH LEAKAGE RATE DISPLAY



Additional performance features compared to LOKTRACER TLD.500:

- ⊕ Robust aluminium housing.
- ⊕ Lit LCD display.
- ⊕ Recovery pump enables leak detection even through floor screed and foam.
- ⊕ Swift, safe leak detection through "Search Mode".
- ⊕ ppm measurement of leak rate through "Analysis Mode".

Article no.	Article name
L13005244	LOKTRACER TLD.1000

Technical data

Time to operability:	< 60 s
Reaction time:	1 to 2 s
Operating time:	Approx. 5 h
Power supply:	Batteries

Also available separately

Article no.	Article name	Description
L14004385	PA-TLD.1000	Mains charger

TRACE GAS LEAK DETECTION KITS

CARRY CASE KIT FOR TRACE GAS LEAK DETECTION IN VEHICLE AIR CONDITIONING SYSTEMS



- ⊕ Complete kit for trace gas leak detection in vehicle air conditioning systems, in a robust carry case.
- ⊕ Pressure reducer connection: W21,8-14 with left-handed thread.

Article no.	Article name	Description
L13005139	LOKBOX TG-AUTO-500	With LOKTRACER TLD.500

Also available separately

Article no.	Article name	Description
L14003951	PR-TG.10 W21,8-14	10 bar (150 psi) pressure reducer
L13005015	PA-1/LT.10	Manifold gauge 10 bar (150 psi)
L13004971	HDS-A-G+G-3000-Y	Charging hose
L13002909	HDS-J-G+G-3000-Y	Charging hose
L14002502	QC-134a-BM	Low pressure quick-coupler
L14002503	QC-134a-RM	High pressure quick-coupler

CYLINDER TROLLEY KIT FOR TRACE GAS LEAK DETECTION IN VEHICLE AIR CONDITIONING SYSTEMS



- ⊕ Complete kit for trace gas leak detection in vehicle air conditioning systems.
- ⊕ The cylinder trolley is suitable for standard 10 l or 20 l gas cylinders.
- ⊕ The gas cylinder pictured is not included.
- ⊕ Pressure reducer connection: W21,8-14 with left-handed thread.

Article no.	Article name	Description
L13005004	LOKTRACE KA-500 W21,8-14	With LOKTRACER TLD.500

Also available separately

Article no.	Article name	Description
L14003939	CT.10/20	Cylinder trolley
L14003951	PR-TG.10 W21,8-14	10 bar (150 psi) pressure reducer
L13005015	PA-1/LT.10	Manifold gauge 10 bar (150 psi)
L13004971	HDS-A-G+G-3000-Y	Charging hose
L13002909	HDS-J-G+G-3000-Y	Charging hose
L14002502	QC-134a-BM	Low pressure quick-coupler
L14002503	QC-134a-RM	High pressure quick-coupler
L14003969	LOKTRACE KA.DC	Dust cover

QUICK-COUPLER FOR HFO-1234YF



- ⊕ Enables the connection of LOKTRACE leak detection kits in vehicle air conditioning systems with the refrigerant HFO-1234yf.
- ⊕ An A-1234 fitting is also required to connect to the charging hose of the LOKTRACE leak detection kit.
- ⊕ Tested according to SAE J2888 (1234yf).
- ⊕ Connection: M12 x 1,5.

Article no.	Article name	Description
L14004188	QC-1234YF-BF	Low pressure quick-coupler
L14004187	QC-1234YF-RF	High pressure quick-coupler

FITTING M12X1,5 M - 1/4" SAE M



To connect LOKTRACE leak detection kit charging hoses with quick-couplers for HFO-1234yf.

Article no.	Article name
L14004189	A-1234

CARRY CASE KIT FOR TRACE GAS LEAK DETECTION IN REFRIGERATION AND AIR CONDITIONING SYSTEMS



- ⊕ Complete kit for trace gas leak detection in refrigeration and air conditioning systems, in a robust carry case.
- ⊕ Pressure reducer connection: W21,8-14 LH with left-handed thread.

Article no.	Article name	Description
L13005038	LOKBOX TG-HVAC-500	With LOKTRACER TLD.500
L13004643	LOKBOX TG-HVAC-1000	With LOKTRACER TLD.1000

Also available separately

Article no.	Article name	Description
L14003411	PR-H2.50	50 bar (750 psi) pressure reducer
L13005037	PA-1/LT.50	Manifold gauge 50 bar (750 psi)
L13004971	HDS-A-G+G-3000-Y	Charging hose
L13002909	HDS-J-G+G-3000-Y	Charging hose

REFRIGERANT LEAK DETECTOR

ELECTRONIC REFRIGERANT LEAK DETECTOR



LOKATOR RLD5



- ⊕ Suitable for HC, PFC and HFC refrigerants.
- ⊕ Made in Germany.
- ⊕ Sensitivity ≤ 1 g/year (in accordance with EN14624, SAEJ1627 and E85-22).
- ⊕ Incremental approximation of major leaks (zero tracking).
- ⊕ Automatic sensor cleaning.
- ⊕ No pump or filter due to diffusion technology.
- ⊕ Integrated LED light.
- ⊕ Acoustic and optical alarm.
- ⊕ Conforms to EC regulations 1516/2007 and DIN 378.

Article no.	Article name
L13005243	LOKATOR RLD5

Technical data

Time to operability:	< 60 s
Reaction time:	1 to 2 s
Operating time:	Approx. 5 h
Power supply:	Rechargeable batteries

Also available separately

Article no.	Article name	Description
L14004043	PA-TLD.500	Mains charger

NITROGEN PRESSURE TESTING

NITROGEN PRESSURE REDUCER 10 bar (150 psi)



Pressure reducer for carrying out pressure testing up to 10 bar (150 psi) in refrigeration and air conditioning systems.

Article no.	Article name	Description
L14000039	PR-N2.10	Nitrogen pressure reducer 10 bar (150 psi)

LEAK DETECTION SPRAY



- ⊕ For the detection of leaks in tube lines under pressure.
- ⊕ Non-flammable, anti-corrosive, tolerated by the skin.
- ⊕ DIN-DVGW tested.

Article no.	Article name	Contents
L14000823	LS-400	400 ml

RECOVERY, EVACUATION, CHARGING

VACUUM METER



VACUUM METER V80

PAGE 15 RECOVERY UNITS

PAGE 16 VACUUM PUMP STATIONS

PAGE 17 VACUUM PUMPS

PAGE 18 MANIFOLD GAUGES

PAGE 20 GAUGES & VACUUM METERS

PAGE 22 CHARGING DEVICE

PAGE 23 DIGITAL SCALES

PAGE 24 CHARGING HOSES

RECOVERY UNITS

COMPACT RECOVERY UNIT



- ⊕ World's smallest, fully adequate recovery unit for all common, non-flammable refrigerants (excluding NH₃).
- ⊕ Safety pressure limiter with automatic reset function.
- ⊕ Simple 2-valve control.
- ⊕ Oil-free compressor for the disposal of liquid and gaseous refrigerants.
- ⊕ Integrated dirt filter.

Article no.	Article name
L14004102	RG3000E

Technical data

Recovery capacity (gaseous):	7 kg/h (15.4 lbs/h)
Recovery capacity (liquid):	40 kg/h (88.2 lbs/h)
Connections:	1/4" SAE
Safety pressure limiter:	38 bar (550 psi)
Pressures in:	bar and psi
Power supply:	220/240 V – 50/60 Hz
L x H x D in mm (inch):	310 x 235 x 175 (12.2 x 9.25 x 6.9)
Weight:	8 kg (17.64 lbs)

RECOVERY UNITS



- ⊕ Compact recovery unit for all common, non-flammable refrigerants (excluding NH₃).
- ⊕ Made in USA.
- ⊕ Oil-free 1/2 PS compressor.
- ⊕ Switches off automatically after process ends.
- ⊕ With „Technical Inspection Association-type“ test.

Article no.	Article name
L14003138	RG-69000-220 TÜV

Technical data

Recovery capacity (gaseous):	30 kg/h (66.14 lbs/h)
Recovery capacity (liquid):	84 kg/h (185.2 lbs/h)
Connections:	1/4" SAE
Safety pressure limiter:	38 bar (550 psi)
Pressures in:	bar and psi
Power supply:	220/240 V – 50/60 Hz
L x H x D in mm (inch):	432 x 254 x 305 (17 x 10 x 12)
Weight:	16 kg (2.2 lbs)

VACUUM PUMP STATIONS

VACUUM PUMP STATION WITH VACUUM PUMP RD.2D



- ⊕ For the evacuation and charging of refrigerant circuits.
- ⊕ 2-stage vacuum pump RD.2D (35 l/min).
- ⊕ Gauge with 80 mm (3.15") diameter.
- ⊕ Compartment for refrigerant scales.
- ⊕ 2 charging hoses 1.5 m (39.4").

Article no.	Article name	Low pressure gauge	High pressure gauge
L13001863	VPS-RD.2D/MN-01/MH-01/V80	R600a	R600a
L13005316	VPS-RD.2D/MN-11/MH-11/V80	R290, R600a	R290, R600a

Article no.	Article name	Low pressure gauge	High pressure gauge
L13001851	VPS-RD.2D/MN-01/MN-07/V80	R600a	R134a

Technical data

Power supply:	220/240 V – 50/60 Hz
L x H x D in mm (inch):	345 x 265 x 360 (13.6 x 10.4 x 14.2)
Weight:	12.2 kg (26.9 lbs)

VACUUM PUMP STATION WITH VACUUM PUMP DIP-402



- ⊕ For the evacuation and charging of refrigerant circuits.
- ⊕ 2-stage vacuum pump DIP-402 (80 l/min).
- ⊕ Gauge with 80 mm (3.15") diameter.
- ⊕ Compartment for refrigerant scales.
- ⊕ 2 charging hoses 1.5 m (39.4").

Article no.	Article name	Low pressure gauge	High pressure gauge
L13005289	VPS-DIP-402/MN-11/MH-11/V80	R290, R600a	R290, R600a

Technical data

Power supply:	220/240 V – 50/60 Hz
L x H x D in mm (inch):	430 x 270 x 360 (16.93 x 10.6 x 14.17)
Weight:	18.5 kg (40.78 lbs)

VACUUM PUMPS

VACUUM PUMP RD.2D



Has a gas ballast valve and thermal overload protection.

Article no.	Article name
L14002963	RD.2D

Technical data

Capacity:	35 l/min
Final partial pressure:	0.01 mbar (0.15 psi)
Connection power:	120 Watt
Power supply:	220/240 V – 50/60 Hz
L x H x D in mm (inch):	247 x 110 x 210 (9.72 x 4.33 x 8.27)
Weight:	6 kg (13.23 lbs)

VACUUM PUMP DIP-402



Has a gas ballast valve and thermal overload protection.

Article no.	Article name
L14001731	DIP-402

Technical data

Capacity:	80 l/min
Final partial pressure:	0.01 mbar (0.15 psi)
Connection power:	300 Watt
Power supply:	220/240 V – 50/60 Hz
L x H x D in mm (inch):	285 x 150 x 260 (11.22 x 5.9 x 10.24)
Weight:	10 kg (22.05 lbs)

MINERAL VACUUM PUMP OIL



1 litre mineral vacuum pump oil.

Article no.	Article name	For vacuum pumps
L13003161	M032	RD.2D
L14000010	M068	DIP-402

MANIFOLD GAUGES

1-VALVE MANIFOLD GAUGES



Gauge with 80 mm (3.15") diameter.

Article no.	Article name	For refrigerant
L13002106	PA-1/MN-01	R600a

2-VALVE MANIFOLD GAUGES



Gauges with 80 mm (3.15") diameter.

Article no.	Article name	For refrigerant
L13001562	PA-2/MN-01/MH-01	R600a

BASIC BODY FOR 1-VALVE MANIFOLD GAUGE



Basic body for a manifold gauge.

Article no.	Article name	Description
L14000837	PA-1/H/GK	Basic body for 1--valve manifold gauge HD

BASIC BODY FOR 2-VALVE MANIFOLD GAUGE



Basic body for manifold gauges.

Article no.	Article name	Description
L14000833	PA-2/GK	Basic body for 2-valve manifold gauge

BASIC BODY FOR 5-VALVE MANIFOLD GAUGE



Basic body for manifold gauges.

Article no.	Article name	Description
L14000835	PA-5/GK	Basic body for 5-valve manifold gauge

COMPLETE DIAPHRAGM SET FOR MANIFOLD GAUGES



Consists of:

- ⊕ Diaphragm.
- ⊕ Spring.
- ⊕ Brass head.
- ⊕ Brass ring.

Article no.	Article name
L14000137	WK-G03

DIAPHRAGM SET FOR MANIFOLD GAUGES



Article no.	Article name
L14000274	WK-G04

VALVE SET FOR MANIFOLD GAUGES



Article no.	Article name	Description
L14000493	WK-07H	HIGH
L14000494	WK-07L	LOW
L14000272	WK-07R	REF
L14000492	WK-07V	VAC

GAUGES & VACUUM METERS

LOW PRESSURE GAUGE



- ⊕ Adjustable and vibration-free.
- ⊕ Diameter 80 mm (3.15").
- ⊕ Connection thread 1/8" NPT.

Article no.	Article name	For refrigerant	Scale [bar]	Scale [psi]
L14000690	MN-01	R600a	-1 to 3	-14.5 to 42
L14000696	MN-07	R134a	-1 to 10	-14.5 to 140
L14002928	MN-11	R290, R600a	-1 to 10	-14.5 to 140

HIGH PRESSURE GAUGE



- ⊕ Adjustable and vibration-free.
- ⊕ Diameter 80 mm (3.15").
- ⊕ Connection thread 1/8" NPT.

Article no.	Article name	For refrigerant	Scale [bar]	Scale [psi]
L14000697	MH-01	R600a	-1 to 10	-14.5 to 140
L14000703	MH-07	R134a	-1 to 30	-14.5 to 450
L14002929	MH-11	R290, R600a	-1 to 30	-14.5 to 430

VACUUM METER



- ⊕ Precision scale from 0 to 1000 mbar.
- ⊕ Diameter 80 mm (3.15").
- ⊕ Connection thread 1/8" NPT.

Article no.	Article name
L14000704	V80

DIGITAL VACUUM METER



- ⊕ For simple and precise vacuum metering between 0 mbar and 16 mbar.
- ⊕ Trend display (rising or sinking pressure) where there is more than 16 mbar.
- ⊕ Auto switch off after 10 minutes, if the measurement value is greater than 16 mbar.
- ⊕ Delivered in a robust plastic case.

Article no. Article name

L14001096 VG64

Technical data

Measuring range:	0 to 16 mbar (0 to 12000 Microns)
Resolution:	0.001 mbar (where measurement value < 0.260 mbar) 1 micron (where measurement value < 200 microns)
Accuracy:	± 10 % (where measurement value < 1000 microns)
Display updates:	2 x per second
Units:	[micron], [psi], [inHg], [mbar] [Pascal], [torr], [mTorr]
Overpressure protection:	Up to 20 bar (290 psi)
Connections:	1/4" SAE
Working temperature:	2 °C to 52 °C (35 °F to 125 °F)
Power supply:	1 x 9 V alkaline battery (not included)
Operation time:	Approx. 35 h
Dimensions, vacuum meter (L x W x H):	140 x 76 x 32 mm (5.51" x 2.99" x 1.26")
Weight, vacuum meter:	190 g (6.7 oz)

CHARGING DEVICE

CHARGING DEVICE



Portable charging device for precise charging of refrigerant circuits.

Article no.	Article name
L13005734*	LOKBOX FE charging device

Also available separately

Article no.	Article name	Description
L14000009	16-C	Quick-coupler
L13005321	EV-600a	Extraction valve
L13000953	FE-600a-SK	PVC hose - 1.1 m (3.61")
L13000950	FE-600a-ESK	Discharge hose - 5 m (16.4")
L14000244	121/T-VK	Ball valve
L13001971	HDS-A-G+G-260	Charging hose
L14000131	NRV-6	Non-return valve
L13001521	HFFB-1	Holder for liquid charging

*Suitable refrigerant cartridges can be found on page 31.

DIGITAL SCALES

COMPACT DIGITAL SCALES



- ⊕ For precise removal of refrigerant from cartridges or aluminium compressed gas cylinders.
- ⊕ Developed especially for VULKAN by SOEHNLE PROFESSIONAL, the leading company in measurement and weighing technology.
- ⊕ Straightforward operation with three buttons.
- ⊕ Easily readable LCD display: Digit height 20 mm.
- ⊕ Without zero-tracking.
- ⊕ Without automatic switch off.
- ⊕ Unit toggle switch g/lb.
- ⊕ Robust aluminum housing.
- ⊕ Battery operated 1 x 9V block*.
- ⊕ Working temperature: 0 °C to 40 °C.

* (not included)

Article no. Article name

L14003840 DSL 5000

Technical data

Weighing range:	5,000 g
Intervals:	1 g
Platform size:	150 x 120 mm
Dimensions (L x W x H):	170 x 150 x 40 mm
Weight:	650 g

DIGITAL SCALES



- ⊕ For the exact determination of refrigerant removal amounts or refrigerant charging amounts.
- ⊕ Robust weighing platform with overload protection.
- ⊕ Separate operating and display unit with large display.
- ⊕ Saves last weight display.
- ⊕ Easy adjustment through integrated spirit level.
- ⊕ USB connection.
- ⊕ Delivered in a robust plastic case.

Article no. Article name

L14001836 SC 98210

Technical data

Weighing range:	110 kg (242.51 lbs)
Resolution:	0.01 kg (0.02 lbs)
Weight units:	[kg], [lbs], [oz]
Accuracy:	± 0.01 kg, ± 0.01 lbs, ± 0.16 oz
Working temperature range:	0 °C to 49 °C (32 °F to 120 °F)
Platform size:	220 x 220 mm (8.66" x 8.66")
Power supply:	9 V alkaline battery

CHARGING HOSES

CHARGING HOSE: 1/4" SAE CONNECTIONS (STRAIGHT)



Connections

- ⊕ 1/4" SAE F straight with valve opener.
- ⊕ 1/4" SAE F straight.

Article no.	Article name	Description
L13002285	HDS-A-G+G-600-B	600 mm, blue
L13002286	HDS-A-G+G-600-R	600 mm, red

CHARGING HOSE: 1/4" SAE CONNECTIONS (1 X STRAIGHT, 1 X 45°)



Connections

- ⊕ 1/4" SAE F with 45° elbow and valve opener.
- ⊕ 1/4" SAE F straight.

Article no.	Article name	Description
L13002023	HDS-A-G+W-1500-B	1500 mm, blue
L13002024	HDS-A-G+W-1500-R	1500 mm, red
L13002154	HDS-A-G+W-1500-Y	1500 mm, yellow
L13002114	HDS-A-G+W-1800-B	1800 mm, blue
L13002115	HDS-A-G+W-1800-R	1800 mm, red
L13002116	HDS-A-G+W-1800-Y	1800 mm, yellow

CHARGING HOSE ACCESSORIES

BALL VALVE



SYMBOLIC IMAGE

Article no.	Article name	Thread
L14000447	121-RG-4	1/4" SAE M x 1/4" SAE F

REPLACEMENT SEALS MADE OF PLASTIC



Article no.	Article name
L14001360	KD-1/4"
L14001361	KD-3/8"

VALVE OPENER



Article no.	Article name
L14000575	D19302

VALVE CORE



Article no.	Article name
L14000113	E-6200a

VALVE CORE REMOVER WITH 3 VALVE CORES



Article no.	Article name
L14000013	E-6200

QUICK-COUPPLERS

QUICK-COUPLER SYSTEM

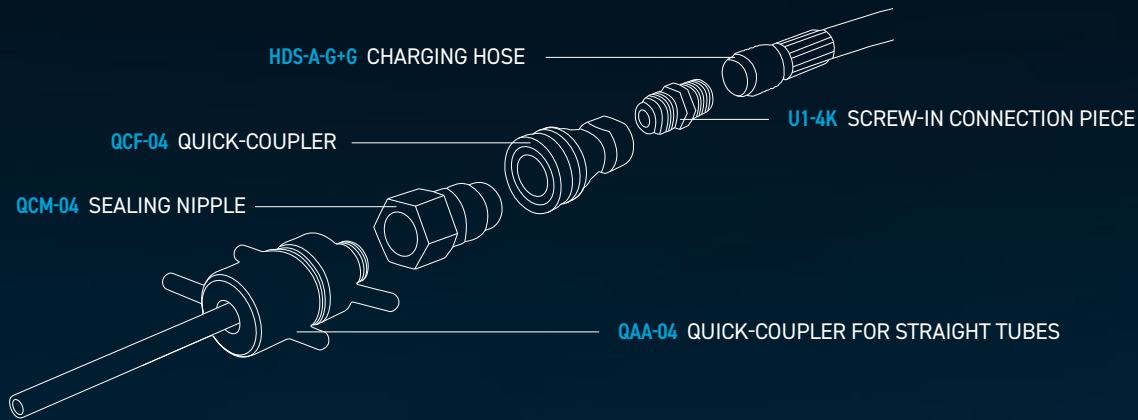

QUICK-COUPERS

1234YF QUICK-COUPLER, CONNECTION M12 X 1.5



- ⌚ Enables the connection of LOKTRACE leak detection kits in vehicle air conditioning systems with the refrigerant HFO-1234yf.
- ⌚ An A-1234 fitting is also required to connect to the charging hose of the LOKTRACE leak detection kit.
- ⌚ Tested according to SAE J2888 (1234yf).
- ⌚ Connection: M12 x 1,5.

Article no.	Article name	Description
L14004188	QC-1234YF-BF	Low pressure quick-coupler
L14004187	QC-1234yf-RF	High pressure quick-coupler

R134a QUICK-COUPERS



- ⌚ Connection 1/4" SAE M.
- ⌚ Tested according to SAE J497 (R134a).

Article no.	Article name	Description
L14002502	QC-134A-BM	Low pressure quick-coupler
L14002503	QC-134a-RM	High pressure quick-coupler

R134a QUICK-COUPERS



- ⌚ Connection M14 x 1,5.
- ⌚ Tested according to SAE J497 (R134a).

Article no.	Article name	Description
L14002484	QC-134a-RF	High pressure quick-coupler

EXTENSION FOR R134a HIGH PRESSURE SERVICE PORT



To extend high pressure service ports that are difficult to access e.g. for BMW E60 (5 Series), Volvo S80 and some Ford models.

Article no.	Article name
L14002876	QC-134A

QUICK-COUPLERS

QUICK-COUPLER FOR SCHRADER VALVES



- ⊕ To open Schrader valves without a loss of refrigerant.
- ⊕ When the quick-coupler is removed, the hose is sealed by the valve.
- ⊕ No valve opener is required in the end of the hose.
- ⊕ Quick-coupler 27-C is suitable for R410A.

Article no.	Article name	Description
L1400009	16-C	1/4" SAE M, straight
L1400053	17-C	1/4" SAE M, 90° angle
L14002678	27-C	5/16" SAE M, 90° angle

Available separately

L14000264	OR-16C	O-Ring for 16-C and 17-C
L14000265	16-C/D	Seal for 16-C and 17-C
L14002926	OR-26C	O-Ring for 26-C and 27-C
L14002927	26-C/D	Seal for 26-C and 27-C
L14002925	26-C/RM	Knurled nut for 26-C and 27-C

QUICK-COUPLER FOR STRAIGHT TUBES



- ⊕ For clamping straight tubes.
- ⊕ Seals at tube intersection and around entire tube circumference.
- ⊕ Suitable for pressure tests and evacuation as well as refrigerant charging.

Article no.	Article name	For ø
L14001655	PCV-600-2-HNBR	6 mm
L14001849	PCV-630-2-HNBR	6,35 mm (1/4")

Technical data

Vacuum-tight	Up to 0.013 mbar (10 micron)
Pressure resistant	Up to 45 bar (650 psi)
Working temperature	-20 °C to 80 °C (-4 °F to 176 °F)
Minimum tube length	19 mm (3/4")
Minimum tube wall thickness	0.8 mm (0.03")

QUICK-COUPLER FOR STRAIGHT TUBES



- ⊕ For clamping straight tubes.
- ⊕ Seals around entire tube circumference.
- ⊕ Ensures maximum flow when flushing air conditioning systems.
- ⊕ Suitable for pressure tests and evacuation as well as refrigerant charging.

Article no.	Article name	For ø
L13002869	SK-40-2	2 mm
L13001369	SK-40-5	5 mm
L13001368	SK-40-6	6 mm
L13001406	SK-40-6,35	6.35 mm (1/4")
L13001431	SK-40-8	8 mm (5/16")
L13001312	SK-40-10	10 mm

Technical data

Vacuum-tight	Up to 0.013 mbar (10 micron)
Pressure resistant	Up to 52 bar (754 psi)

QUICK-COUPLER FOR SEAL NIPPLE QCM



Anvil with internal thread.

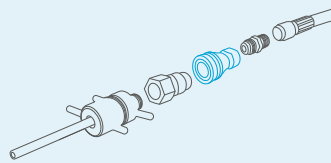

Article no.	Article name	Connection
L14000045	QCF-04	1/4" NPT F
L14001808	QCF-04-H.NBR	Rc 1/4"

SEAL NIPPLE FOR QUICK-COUPLER QCF



Connection adapter.

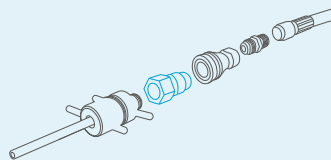

Article no.	Article name	Connection
L14000046	QCM-04	1/4" NPT F
L14001795	QCM-04-H.NBR	Rc 1/4"

QUICK-COUPLER FOR STRAIGHT TUBES

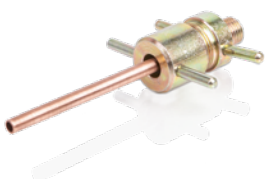

The two adapters have the same structure, but differ in the quick-coupler inserts and seals used.

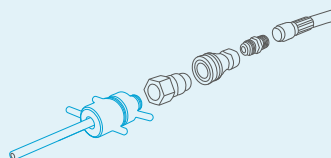

Article no.	Article name	For ϕ
L14000030	QAA-04	6 mm

Available separately

L14000082	QAI-04	Quick-coupler insert
L14000028	QAI-05	Quick-coupler insert
L14000083	QAG-04	Seal
L14000021	QAG-05	Seal

REFRIGERANTS

RECOVERY

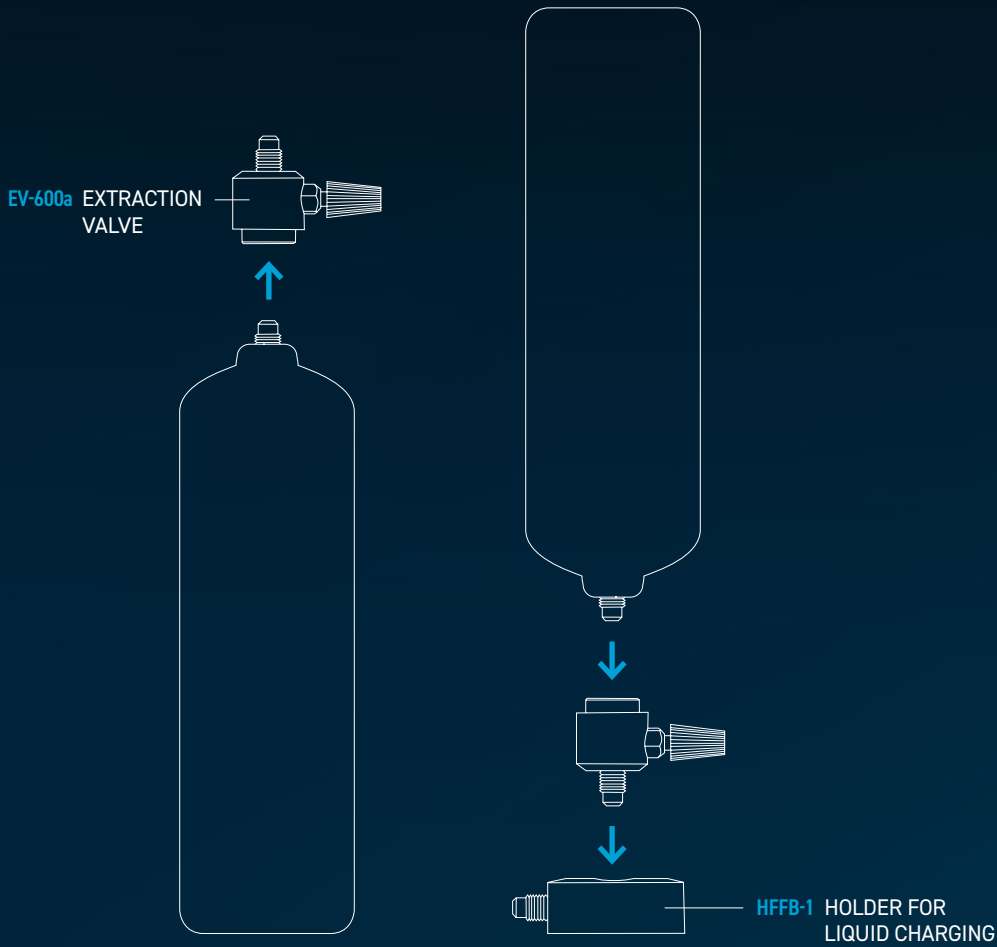

REFRIGERANTS

R290 REFRIGERANT CARTRIDGE



Article no.	Article name	Contents
L14004254	REF-R290-03*	370 g (13.05 oz)

*NOTE: Cartridge does not fit into the carrying case of LOKBOX FE (L13005734).

R600a REFRIGERANT CARTRIDGE



Article no.	Article name	Contents
L14000125	REF-R600a**	420 g (14.82 oz)

**NOTE: Cartridge fits into the carrying case of LOKBOX FE (L13005734).

EXTRACTION VALVE FOR R290 CARTRIDGES



Article no.	Article name
L14004255	EV-290-03

EXTRACTION VALVE FOR R600a CARTRIDGES



Article no.	Article name
L13005321	EV-600a

HOLDER FOR LIQUID CHARGING



Article no.	Article name
L13001521	HFFB-1

ADAPTER FOR NON-FLAMMABLE REFRIGERANT



Article no.	Article name	Connections
L14000689	W21,8-14	W21,8-14 x 1/4" SAEM

MEASUREMENT AND DIAGNOSTIC DEVICES

INFRARED THERMOMETER

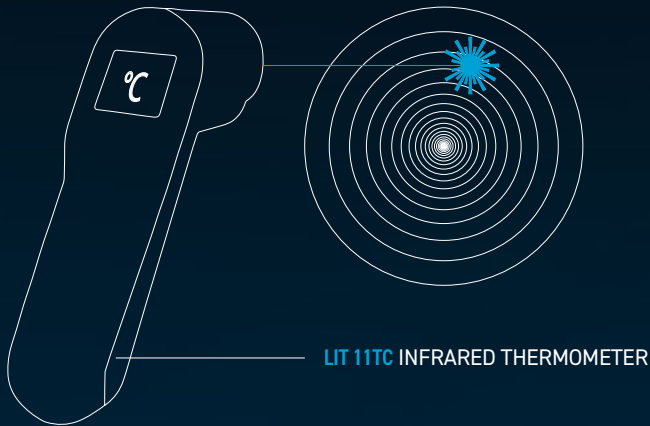

PAGE 33 INFRARED THERMOMETER

PAGE 34 DIGITAL QUICK RESPONSE THERMOMETER

PAGE 35 PROBE

PAGE 35 TEMPERATURE LOGGER

INFRARED THERMOMETER

INFRARED THERMOMETER



- ⊕ For precise, non-contact temperature measurement on non-reflective surfaces.
- ⊕ With additional K-type thermocouple.

Article no.	Article name
L14002969	LIT 11TC

Technical data

Optical resolution:	11:1
Temperature range:	-60 °C to 500 °C (-76 °F to 932 °F)
Resolution:	0.1 °C (0.1 °F)
Accuracy:	± 1 °C (1.8 °F)
Emission coefficient:	0.95 adjustable
K-type thermocouple:	Yes (probe included)
Probes included in the temperature range:	14 °C to 250 °C (57 °F to 482 °F)
Total temperature range:	-64 °C to 1400 °C (-83 °F to 2552 °F)
Temperature accuracy:	± 1% or 2 °C (3.6 °F)
Display:	LCD, lit
Automatic switch off:	Yes
Power supply:	2 x AA batteries (included)
Weight:	179 g (6.31 oz)
Dimensions:	175 x 39 x 71 mm (6.89" x 1.54" x 2.80")

DIGITAL QUICK RESPONSE THERMOMETER

DIGITAL QUICK RESPONSE THERMOMETER



Digital quick response thermometer, freely combinable with the probes shown on the right.

- ⊕ Digital quick response thermometer.
- ⊕ Alkaline battery 9 V.

Article no.	L14000527	L14000817
Article name	GTH-1150	GTH-1160

Technical data		
Probe (not included):	1	1
Number of measuring ranges:	1	2
Measuring range 1:	-50 °C to 1150 °C	-50 °C to 1150 °C
Measuring range 2:	-	-50 °C to 199.9 °C
Accuracy of measuring range 1:	± 1.0%: 20 °C to 550 °C; 920 °C to 1150 °C ± 1.5%: 550 °C to 920 °C	± 1.0%: 20 °C to 550 °C; 920 °C to 1150 °C ± 1.5%: 550 °C to 920 °C
Accuracy of measuring range 2:	-	± 1.0%: 20 °C to 199 °C
Resolution of measuring range 1:	1 °C	1 °C
Resolution of measuring range 2:	-	0,1 °C
Temperature difference measurement:	No	No
Working temperature:	0 °C to 45 °C (32 °F to 113 °F)	0 °C to 45 °C (32 °F to 113 °F)
Power supply:	1 x 9 V alkaline battery	1 x 9 V alkaline battery
Dimensions (L x W x H):	106 x 67 x 30 mm (4.17" x 2.64" x 1.18")	106 x 67 x 30 mm (4.17" x 2.64" x 1.18")
Weight (including battery):	150 g (5.29 oz)	150 g (5.29 oz)

CARRY CASE KIT INCLUDES PROBE



- ⊕ Digital quick response thermometer.
- ⊕ Probe GTF-300 GS.
- ⊕ Alkaline battery 9 V.
- ⊕ Plastic carry case.

Article no.	Article name	Description
L13001858	K GTH-1160	Carry case kit includes probe

PROBE AND TEMPERATURE LOGGER

PROBE FOR DIGITAL QUICK RESPONSE THERMOMETER



Article no.	Article name
L14001898	GOF 500

Technical data

Measuring range:	-265 °C to 500 °C (-445 °F to 932 °F)
Area of application:	Gases, liquids and solid surfaces
Length:	1 m (3.28")

PROBE FOR DIGITAL QUICK RESPONSE THERMOMETER



Article no.	Article name
L14000889	GTF-300 GS

Technical data

Measuring range:	-65 °C to 400 °C (-85 °F to 752 °F)
Area of application:	Gases, solid surfaces (not just liquids)
Length:	1 m (3.28")

TEMPERATURE LOGGER



Standalone USB-based mini-data logger for measurements in critical climatic conditions.

Performance features

- ⊕ Delayed start or recording review via a push button.
- ⊕ Temperature alarm with optical display on request.
- ⊕ User can select stop when memory is full, or memory roll-over for continuous recording.
- ⊕ Real-time monitoring.
- ⊕ USB connection.
- ⊕ Windows compatible software.

Scope of supply

- ⊕ SL 300 T temperature logger.
- ⊕ Windows-based software compatible with 98SE, ME, 2000, XP, VISTA 32-bit Version (not compatible with Windows 95, NT, VISTA 64-bit Version, Windows 7 and Windows 10).
- ⊕ USB connection cable.
- ⊕ 3 V alkaline batteries.

Article no.	Article name	Description
L14003035	SL 300 T	Temperature logger

Technical data

Measuring points:	44,344
Sampling rate:	1 second to 18 hours
Alarm:	Over and under-range alarm
Temperature measuring range:	-40 °C to 85 °C (-40 °F to 185 °F)
Temperature accuracy:	± 0.5 °C (1 °F)
Temperature resolution:	0.01 °C (0.02 °F)
Calibration:	One-point offset calibration through software
Time Accuracy:	± 100 ppm at 24 °C (75.2 °F)
Dimensions (L x W x H):	76 x 40 x 15 mm (2.99" x 1.57" x 0.59")
Power supply:	3 V lithium battery (CR 2035)
Battery lifespan:	Approx. 6 years

FITTINGS

FITTINGS

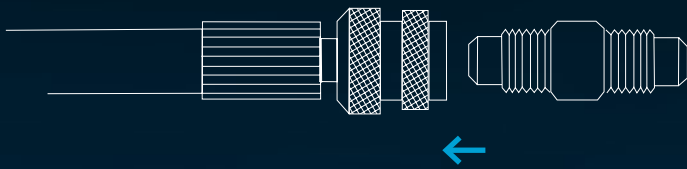

FITTINGS

SCREW-IN CONNECTION PIECE



Article no.	Article name	Connections
L14000047	U2-4	1/4" SAE M - 1/4" SAE M

SCREW-ON CONNECTION PIECE



Article no.	Article name	Connections
L12002418	U1-7K	Rc 1/4" - 1/4" SAE M

ELBOW CONNECTORS



Article no.	Article name	Connections
L14000300	ES4-66	3/8" SAE F - 3/8" SAE M

SLEEVES



Article no.	Article name	Connections
L14000445	U4-4	1/4" SAE F - 1/4" SAE F

COMPRESSORS

COMPRESSOR

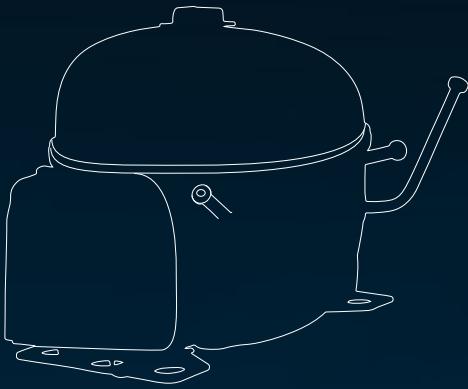

PAGE 39 R600a COMPRESSORS

PAGE 39 COMPRESSOR PRESSURE TESTING DEVICE

COMPRESSORS AND COMPRESSOR PRESSURE TESTING DEVICE

R600a COMPRESSORS



- ⊕ For refrigeration and freezer devices.
- ⊕ Complete with all electrical parts as well as rubber feet and humidifier tray.
- ⊕ The compressors are compatible with other types of compressors (see compatibility chart).
- ⊕ Power supply: 220/240 V, 50 Hz.
- ⊕ The compatibility list was created based on the manufacturer information. We therefore recommend that only the compressors specified are used; and exclude all liability for consequential damages where any other compressors are used.

Article no.	L14000485	L14000483	L14000482
Article name	C-R600a-1/4	C-R600a-1/6	C-R600a-1/8

Technical data

PS:	1/4	1/6	1/8
Refrigeration capacity kcal/h:	100	116	104
Refrigeration capacity watts:	233	135	121
Volumetric delivery cm ³ :	14.28	7.96	7.23
Nom. power consumption watts:	175.0	102.0	91.0
Dimensions L x W x D mm (inch):	220 x 250 x 180 (8.66 x 9.84 x 7.09)	180 x 220 x 150 (7.09 x 8.66 x 5.91)	170 x 230 x 150 (6.69 x 9.06 x 5.91)
Weight kg (lbs):	10.7 (23.6)	7.7 (17.0)	7.1 (15.7)

Compatible with

Aspera	NBM1118Y	BPK1111Y	BPK1084Y
Danfoss	NLE15K/NL15K	TLES9K/TLS9K	TLES7K/TLS7K
Elektrolux	HP16AH	HL99AH/HL99AA/ HL90AH/HL90AA	HL70AH/HL70AA/HL67AH
Matsushita			SD65E
Embraco		EMI40CEP/EMI40CSC	EMI30CEP/EMI30CSC

COMPRESSOR PRESSURE TESTING DEVICE



To check the performance of compressors.

Scope of supply

- ⊕ Pressure vessel with gauge (16 bar, filled with glycerine).
- ⊕ adjustable safety valve.
- ⊕ Charging hose NFS-A-G+W-1500-B.
- ⊕ Case.

Article no.	Article name
L13002291	KP-DG

USEFUL ACCESSORIES

DIGITAL CALIPER

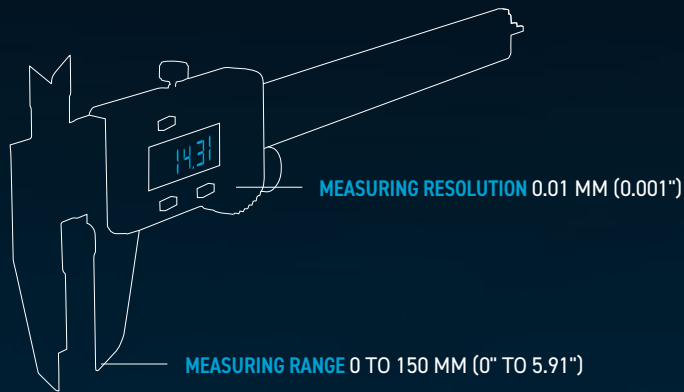

USEFUL ACCESSORIES

FLARING TOOL



- ⊕ For easy and fast expansion of soft copper, aluminium or brass tubes with metric or imperial diameters.
- ⊕ Suitable for tube outer diameters of 5 to 16 mm (3/16" to 5/8").

Article no.	Article name
L14002017	VRC2.D

COLD RATCHET



Cold ratchet with usable spanners on both sides for 9/16" and 1/2" hexagon heads and 1/4" and 3/16" squares.

Article no.	Article name
L14001251	KN-70081

USEFUL ACCESSORIES

COOLING SPRAY



In spray cans, for testing thermostats up to -50 °C (-58 °F).

Article no.	Article name	Contents
L14000311	BR-400	400 ml

DIGITAL CALIPER



Measuring range: 0 to 150 mm (0" to 5.91") Measurement units: Metric/ imperial.

Article no.	Article name
L14003948	DGMS 150

REPAIR KIT



For sealing aluminium evaporators. Temperature resistant from -35 °C to 120 °C (-31 °F to 248 °F) and pressure resistant up to 84 N/mm².

Article no.	Article name	Contents
L14000688	AL-115	57 g (2 oz)

FIN COMB SET



For smoothing and cleaning of evaporator and condenser fins.

Article no.	Article name
L14001031	FCR6

NOTES

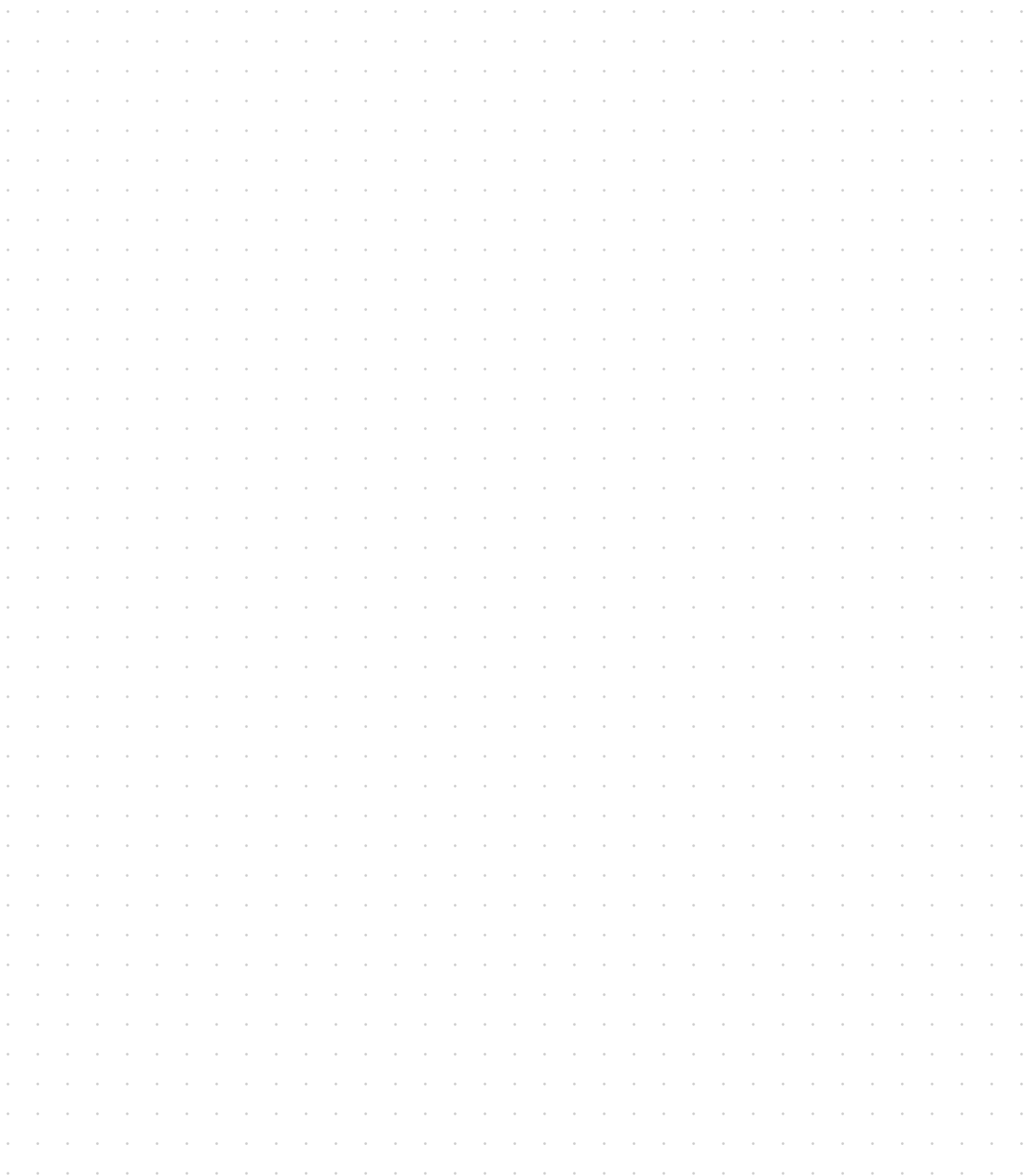

ONLINE-SERVICE

FOR FURTHER INFORMATION, PLEASE REFER
TO OUR WEBSITE WWW.VULKAN.COM



AUTHORISED DISTRIBUTORS

www.vulkan.com/en-us/lokring/contact/



VIDEOS

www.vulkan.com/en-us/lokring/videos/



TECHNICAL DOCUMENTATION AND SUBMITTAL

www.vulkan.com/en-us/lokring/downloads/technical-documentation-and-submittal



CATALOGUES & BROCHURES

www.vulkan.com/en-us/lokring/downloads/



CERTIFICATES

www.vulkan.com/en-us/lokring/downloads/certificates/

IMPRINT

PUBLISHER:

VULKAN Lokring
Rohrverbindungen GmbH & Co. KG
Heerstraße 66, 44653 Herne / Germany
Tel.: + 49 (23 25) 922-155
E-mail: info.lok@vulkan.com

CONCEPT AND DESIGN:

Hackforth Holding GmbH & Co. KG
VULKAN Marketing
Heerstraße 66, 44653 Herne / Germany
E-mail: marketing@vulkan.com

PREPRESS:

Hackforth Holding GmbH & Co. KG
VULKAN Marketing
Heerstraße 66, 44653 Herne / Germany
E-mail: marketing@vulkan.com

VALIDITY CLAUSE

The LOKRING® tube connection technology represents a proven method of producing hermetically sealed metal-to-metal tube connections. The LOKRING® tube connections are mainly used in the refrigeration and air conditioning industries. The use of LOKRING® tube connection technology in other fields is to be discussed with VULKAN. VULKAN as the supplier is responsible for the qualitative delivery of the tube connections and tools which are ordered from this catalogue.

The purchaser is responsible for the use of the LOKRING® tube connections and tools as directed. The assembly has to be done accordingly to the instructions and exclusively with original LOKRING® parts. The present Service Equipment catalogue shall replace all previous editions, any previous printings shall no longer be valid. The data contained in this catalogue refers to the valid state of affairs in time of the copy deadline. Any changes due to technical progress are reserved.

Status: 06/2024

All duplication, reprinting and translation rights are reserved. Further remarks for the LOKRING® assembly are available on request.

Article no.: L19000322

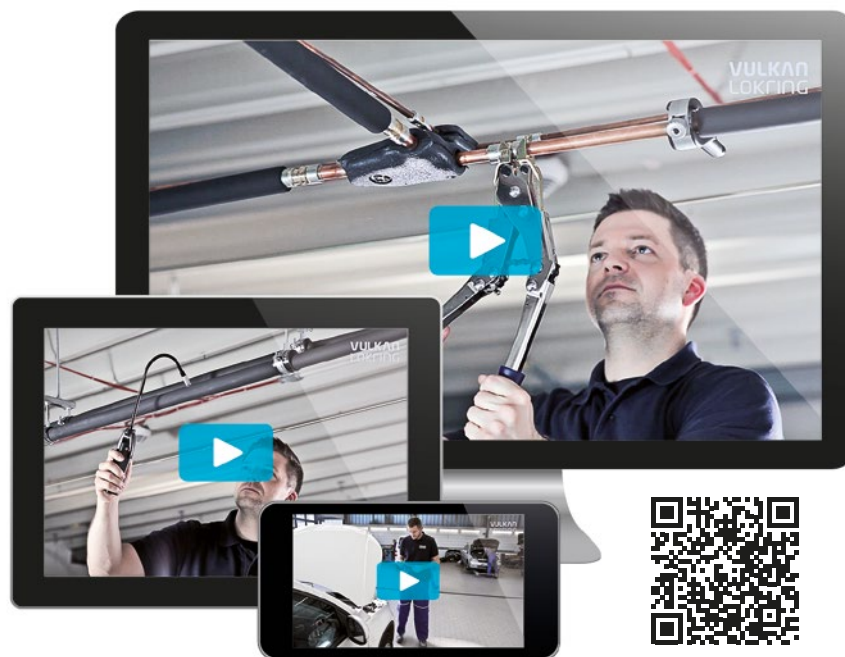

www.vulkan.com/en-us/lokkring/videos/