

We ensure that systems work better.

VULKAN

Marine and Industrial Solutions

N-FLEX[®]

Flexible drive shaft Flexible Antriebswelle

Torque range Drehmomentbereich

1,75 kNm – 14,00 kNm

Drive shaft technology by

 NEMOS



CONTENTS INHALT

Introduction Einführung	04	Summary of Series Baureihenübersicht	16	N-Flex® Compact 5001 Geometric Data Geometrische Daten	22
The VULKAN Group Die VULKAN Gruppe	05	N-Flex® Compact Performance Data Leistungsdaten	18	N-Flex® Medium 5001 Geometric Data Geometrische Daten	23
Characteristics Eigenschaften	11	N-Flex® Medium Performance Data Leistungsdaten	19	Permissible speed Zulässige Drehzahl	24
The NEMOS-Technologie Die NEMOS-Technologie	12	N-Flex® Compact 5000 Geometric Data Geometrische Daten	20	Explanations of the product code Erläuterungen des Produktcodes	25
Connection Possibilities Anschlussmöglichkeiten	15	N-Flex® Medium 5000 Geometric Data Geometrische Daten	21	Validity Clause Gültigkeitsklausel	26



VULKMAN

The VULKAN Group, into which the VULKAN company founded in 1889 is integrated today, is composed of three business areas: Marine / Industry and Energy / Refrigeration and Air Conditioning. The VULKAN Group is solely owned by the Hackforth family in the fourth generation.

Our global presence makes it possible for us to provide our customers with fast, customized solutions on site, a decisive competitive advantage. Our 1,800 employees work at 18 sites around the world; our customers can also find a personal contact in our VULKAN agencies covering 51 countries. For our customers this means that our specialists and the matching solutions are quickly available right where they are needed.

Die VULKAN Gruppe, in die heute die 1889 gegründete Firma VULKAN integriert ist, setzt sich aus den drei Unternehmensbereichen Marine / Industrie- und Energietechnik / Kälte- und Klimatechnik zusammen. Die VULKAN Gruppe befindet sich in der vierten Generation im alleinigen Besitz der Familie Hackforth.

Unsere globale Präsenz versetzt uns in die Lage, unseren Kunden vor Ort schnelle und maßgeschneiderte Lösungen anzubieten, ein entscheidender Wettbewerbsvorteil. Unsere rund 1.800 Mitarbeiter arbeiten an 18 Standorten weltweit, zusätzlich finden unsere Kunden ihre Ansprechpartner in unseren Vertretungen in 51 Ländern der Erde. Für unsere Kunden heißt das: Unsere Spezialisten und die passenden Lösungen sind schnell und auf kurzen Wegen verfügbar – da, wo sie gebraucht werden.



 5 Production sites / 5 Produktionsstätten
 18 Operating Companies / 18 Standorte



MARINE APPLICATIONS

VULKAN flexible couplings and mounts are used on nearly all types of ships with diesel mechanic, hybrid or electric drive concepts. Large cruise ships such as the Aida Stella, workboats such as the ice-breaking drill ship Stena IceMAX or the jack-up vessel Innovation and boats for leisure activities can all benefit from the outstandingly dynamic properties and the long product lifetime of VULKAN products made in one of our production locations.

MARINE ANWENDUNGEN

Elastische Kupplungen und Lagerungen von VULKAN werden in fast allen Schiffstypen mit diesel-mechanischen, Hybrid oder elektrischen Antriebskonzepten eingesetzt. Große Kreuzfahrtschiffe wie die Aida Stella, Arbeitsboote wie das eisbrechende Bohrschiff Stena IceMAX oder das Hub-schiff Innovation und Boote für Freizeitaktivitäten können alle von den herausragenden dynamischen Eigenschaften und der langen Lebensdauer der an einem unserer Produktionsstandorte hergestellten Kupplungen profitieren.

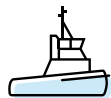

Tugs
Schlepper



Yachts
Yachten



Navy
Navy

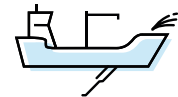

Dredgers
Schwimmbagger

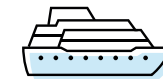

Cruise ships and ferries
Kreuzfahrtschiffe und Fähren



Workboats
Arbeitsboote



INDUSTRIAL APPLICATIONS

VULKAN offers a range of solutions for industrial drives and brake systems. Hereby the technical know-how is centered on more than 20 different application types within six different industrial market segments.

INDUSTRIEANWENDUNGEN

VULKAN bietet eine Reihe von Lösungen für industrielle Antriebe und Bremssysteme. Dabei konzentriert sich das technische Know-how auf mehr als 20 unterschiedliche Anwendungstypen innerhalb von sechs unterschiedlichen Marktsegmenten des Industriesektors.

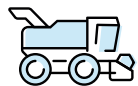

Agricultural Machinery
Landwirtschaftliche Maschinen



Construction and Cement
Bauwesen und Zement



Mining and Mineral Processing
Bergbau, Mineralienverarbeitung



Oil, Gas and Petrochemical
Öl, Gas und Petrochemie



Ports
Häfen



Pulp and Paper
Zellstoff und Papier



Rail
Schienen

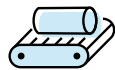

Iron and Steel
Eisen und Stahl



Sugar and Ethanol
Zucker und Ethanol



Power Plants
Kraftwerke

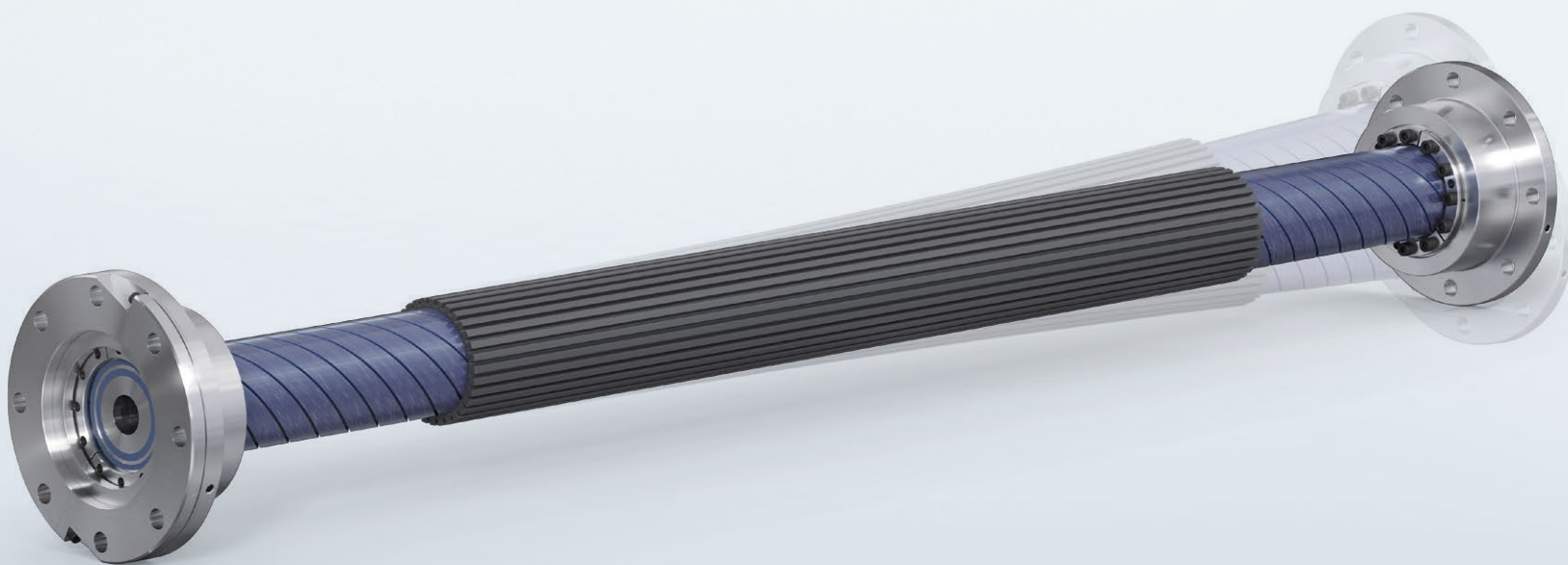

TORQUE DREHMOMENT

1,75 kNm – 14,00 kNm

The new VULKAN N-Flex® drive shaft is based on the patented NEMOS technology featuring a design consisting of fiber-reinforced composite and elastomer material. It offers a unique combination of torsional elasticity and high displacement capacity in one single component. The N-Flex® combines the functions of elastic couplings and drive shafts, reducing the number of components and mass of the driveline.

Areas of Application

Marine Applications, Industrial Applications

Benefits

- ⊕ High torsional elasticity
- ⊕ High flexibility in axial, radial, and angular direction
- ⊕ Maintenance free
- ⊕ Good structure-borne noise isolation
- ⊕ Weight reduction
- ⊕ Low reaction forces
- ⊕ Corrosion resistant
- ⊕ Long unsupported shafts
- ⊕ Customized design possible

Die neue VULKAN N-Flex® Antriebswelle basiert auf der patentierten NEMOS-Technologie, einer Konstruktion aus Faserverbundwerkstoff und Elastomermaterial. Sie vereint Torsionselastizität und hohe Verlagerungsfähigkeit in einem einzigen Bauteil. Damit kombiniert die N-Flex® Funktionen von elastischen Kupplungen und Antriebswellen und reduziert so die Anzahl der Komponenten und die Masse des Antriebsstrangs.

Einsatzgebiete

Marineanwendungen, Industrieanwendungen

Vorteile

- ⊕ Hohe Torsionselastizität
- ⊕ Hohe Nachgiebigkeit in axialer, radialer und winkelliger Richtung
- ⊕ Wartungsfrei
- ⊕ Gute Körperschallisolierung
- ⊕ Gewichtsreduzierung
- ⊕ Geringe Reaktionskräfte
- ⊕ Korrosionsbeständig
- ⊕ Lange freitragende Wellen
- ⊕ Kundenspezifisches Design möglich

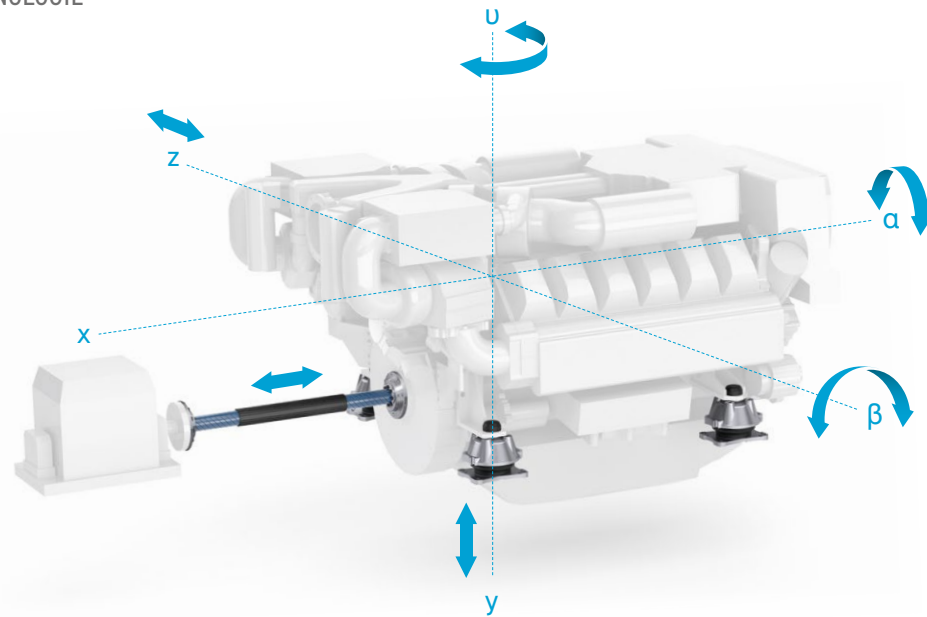

Benefits:

The N-Flex® drive shaft uniquely combines many customer requirements in one single maintenance-free component.

The flexible design compensates for axial, radial and angular displacements and vibrations of the drive components as well as torsional vibrations induced by the engine and offers a high structure-borne noise isolation.

A reduction of components in the drive train can be achieved by one integral product: the N-Flex®.

Vorteile:

Die N-Flex® Antriebswelle vereint in einzigartiger Weise viele Kundenanforderungen in einem einzigen wartungsfreien Bauteil.

Die flexible Konstruktion gleicht axiale, radiale und winklige Verlagerungen und Schwingungen der Antriebskomponenten sowie vom Motor induzierte Drehschwingungen aus und gewährleistet eine hohe Körperschallisolierung.

Eine Reduzierung der Komponenten im Antriebsstrang kann durch ein integrales Produkt erreicht werden: die N-Flex®.

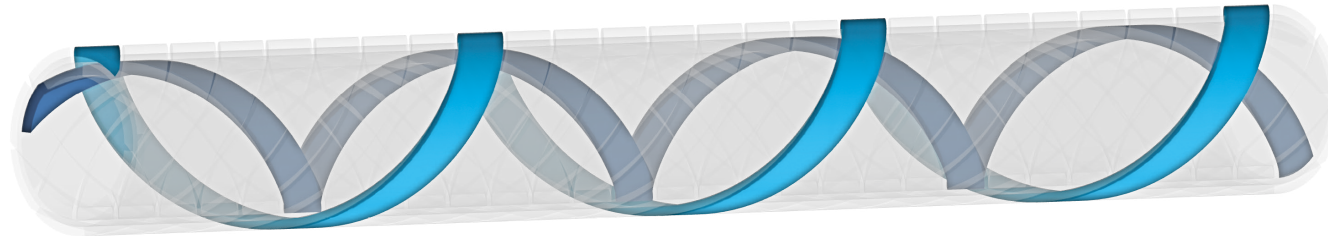
**Technology:**

Unidirectional glass fibers are arranged in two layers of composite coils, transmitting the torque of the drive train. The outer set of coils is purely tension-loaded while the inner coils are compression-loaded, resulting in radial and axial equilibrium of forces. The composite coils of each layer are decoupled by gaps, the outer and inner layer are decoupled by high-performance elastomer material. This allows the coils to remain bending compliant, which enables the entire shaft to be flexible in multiple directions. In addition, the decoupling causes an almost uniaxial tension in the transmission of the torque through the fibre composite helices, allowing high elongations, which gives the N-Flex® drive shaft excellent torsional elasticity.

Get in touch to find out how N-Flex® drive shafts can be implemented and improve your application.

Technologie:

Unidirektionale Glasfasern sind in zwei Lagen mit gegenläufigen Wendeln angeordnet und übertragen das Drehmoment des Antriebsstrangs. Die Faserverbund-Wendeln der äußeren Lage sind rein zugbelastet, während die inneren Wendeln auf Druck beansprucht werden, was zu einem radialen und axialen Kräftegleichgewicht führt. Die Wendel jeder Lage sind durch Spalte voneinander entkoppelt, die beiden Lagen sind durch ein Hochleistungselastomer entkoppelt. Dadurch bleiben die Wendel biegeelastisch, sodass die gesamte Welle in mehrere Richtungen flexibel ist. Darüber hinaus bewirkt die Entkopplung eine nahezu einachsige Spannung bei der Übertragung des Drehmoments durch die Faserverbund-Wendeln, wodurch hohe Dehnungen zulässig sind, was der N-Flex® Antriebswelle eine hervorragende Torsionselastizität verleiht.

Kontaktieren Sie uns, um herauszufinden, wie die N-Flex® Antriebswellen in Ihrer Anwendung eingesetzt werden können.



CONNECTION POSSIBILITIES ANSCHLUSSMÖGLICHKEITEN

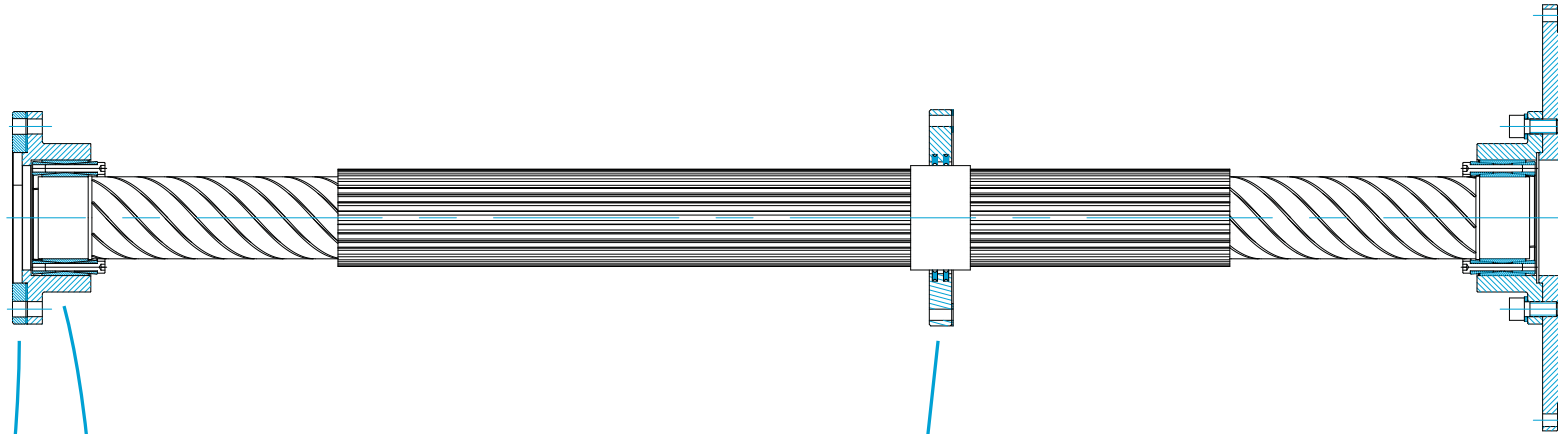

Example Beispiel

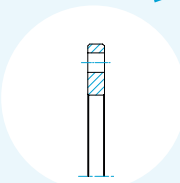
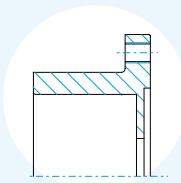
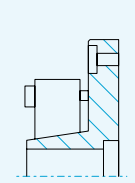
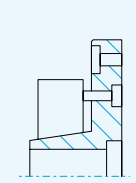
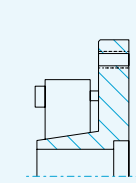
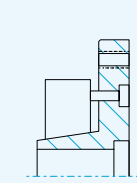
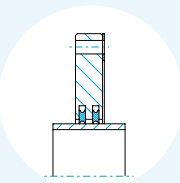
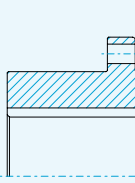
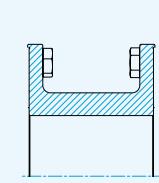
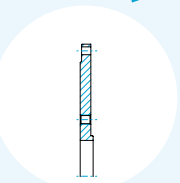
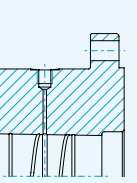
										
Split ring Geteilter Ring	Cardan shaft connection Gelenkwellenanschluss	Clamping-Hub A Klemmnabe A	Clamping-Hub B Klemmnabe B	Clamping-Hub C Klemmnabe C	Clamping-Hub D Klemmnabe D	Bulkhead seal Schottwanddichtung	Keyway connection Passfederverbindung	Double flange Doppelflansch	SAE connection SAE-Anschluss	Oil press fit Ölpressverband

Special requests on demand Sonderwünsche auf Anfrage

SUMMARY OF SERIES BAUREIHENÜBERSICHT



5000 Series N-FLEX® Compact

Especially suitable for limited installation spaces with the requirement for high displacements.
For Connecting two flanges with cardan shaft connections.

Besonders geeignet für begrenzte Einbauträume mit der Anforderung hoher Verlagerungen.
Zur Verbindung zweier Flansche mit Gelenkwellenanschlüssen.

Dimension Group Baugruppe	N070 – N140		
Load range Lastbereich	1,75 – 14,0 kNm	Page Seite	20

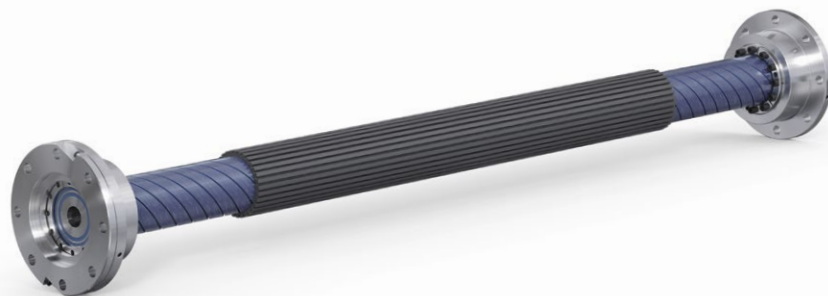

5000 Series N-FLEX® Medium

Thanks to its special design, the Medium series can bridge distances of up to 2 meters while simultaneously compensating for high displacement values.
For Connecting two flanges with cardan shaft connections.

Durch das spezielle Design kann die Baureihe Medium Distanzen von bis zu 2 Metern überbrücken bei gleichzeitigem Kompensieren von hohen Verlagerungswerten.
Zur Verbindung zweier Flansche mit Gelenkwellenanschlüssen.

Dimension Group Baugruppe	N070 – N140		
Load range Lastbereich	1,75 – 14,0 kNm	Page Seite	21

SUMMARY OF SERIES BAUREIHENÜBERSICHT

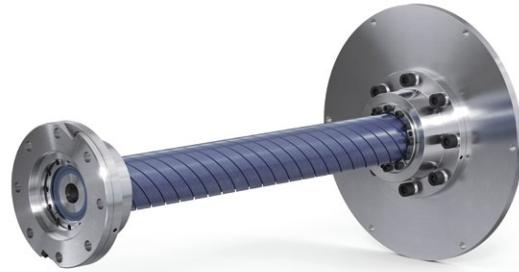

5001 Series N-FLEX® Compact

Especially suitable for limited installation spaces with the requirement for high displacements. For Connecting an SAE-flywheel with a flange with cardan shaft connection.

Besonders geeignet für begrenzte Einbauräume mit der Anforderung hoher Verlagerungen. Zur Verbindung eines SAE Schwungrades mit einem Flansch mit Gelenkwellenanschluss.

Dimension Group Baugruppe	N070 – N140
------------------------------	-------------

Load range Lastbereich	1,75 – 14,0 kNm
---------------------------	-----------------

Page Seite	22
---------------	----

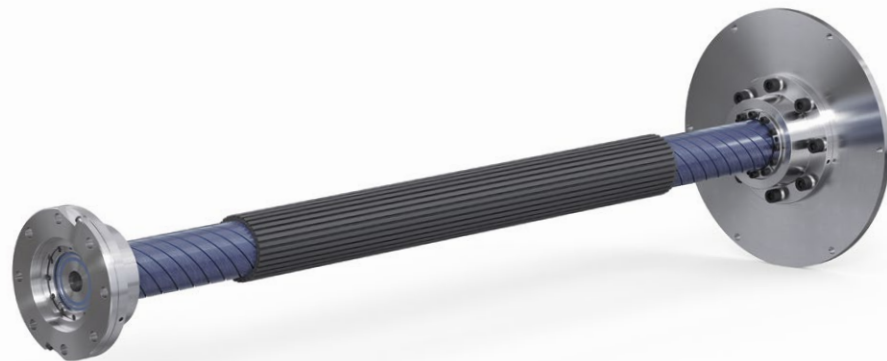

5001 Series N-FLEX® Medium

Thanks to its special design, the Medium series can bridge distances of up to 2 meters while simultaneously compensating for high displacement values.

For Connecting an SAE-flywheel with a flange with cardan shaft connection.

Durch das spezielle Design kann die Baureihe Medium Distanzen von bis zu 2 Metern überbrücken bei gleichzeitigem Kompensieren von hohen Verlagerungswerten.

Zur Verbindung eines SAE Schwungrades mit einem Flansch mit Gelenkwellenanschluss.

Dimension Group Baugruppe	N070 – N140
------------------------------	-------------

Load range Lastbereich	1,75 – 14,0 kNm
---------------------------	-----------------

Page Seite	23
---------------	----

N-FLEX[®] COMPACT



PERFORMANCE DATA LEISTUNGSDATEN



Size code	Dimension group	Permissible Values										Coupling parameters				
		BR	L ₁	L ₃	T _{KN} ³⁾	T _{Kmax1} ³⁾	T _{KW}	P _{KV30} ²⁾	n _{Kmax} ²⁾⁴⁾	ΔK _A ²⁾	ΔK _R ²⁾	ΔK _W ²⁾	C _{Adyn} ¹⁾²⁾	C _{Rdyn} ¹⁾²⁾	C _{Tdyn} ¹⁾²⁾	ψ ¹⁾
		[-]	Total length	Free Length	Nominal Torque	Max Torque ¹	Vibratory Torque	Power Loss	Rotational Speed	Axial Coupling Displacement	Radial Coupling Displacement	Angular Coupling Displacement	Dynamic axial stiffness	Dynamic radial Stiffness	Dynamic torsional stiffness	Relative Damping
			[mm]	[mm]	[kNm]	[kNm]	[kNm]	[kW]	[1/min]	[mm]	[mm]	[deg]	[N/mm]	[N/mm]	[kNm/rad]	[-]
N 070	COMPACT		500	314	1,75	2,60	0,40	0,104	4.500	2,70	2,30	0,85	1.465	274,60	28,70	0,05
N 090	COMPACT		500	310	3,70	5,60	0,90	0,125	4.500	2,80	2,00	0,85	2.453	779,70	79,30	0,05
N 110	COMPACT		500	300	6,80	10,20	1,70	0,143	4.500	2,40	0,90	0,85	3.786	1919,70	182,90	0,05
N 140	COMPACT		500	236	14,00	21,00	3,50	0,136	4.500	2,30	1,00	0,85	7.797	10.346,70	610,20	0,05
N 070	COMPACT		1.000	814	1,75	2,60	0,40	0,269	3.700	7,10	11,00	0,85	565	15,80	11,10	0,05
N 090	COMPACT		1.000	810	3,70	5,60	0,90	0,328	4.500	7,10	8,90	0,85	939	43,70	30,40	0,05
N 110	COMPACT		1.000	800	6,80	10,20	1,70	0,380	4.500	6,80	6,70	0,85	1.420	101,20	68,60	0,05
N 140	COMPACT		1.000	736	14,00	21,00	3,50	0,424	4.500	6,60	5,10	0,85	2.500	341,10	195,70	0,05

See explanation of the technical data.

- 1) Material-related tolerances of +/- 15 % possible
- 2) Permissible values or coupling parameters depending on length
- 3) Values valid for the preferred direction of rotation (see product code)
- 4) Higher values on request

Siehe Erläuterung der Technischen Daten.

- 1) Materialbedingte Toleranzen von +/- 15 % möglich
- 2) Zulässige Werte bzw. Kupplungskennwerte längenabhängig
- 3) Werte gültig für die Vorzugsdrehrichtung (siehe Produktcode)
- 4) Höhere Werte auf Anfrage

N-FLEX® MEDIUM



PERFORMANCE DATA LEISTUNGSDATEN



Size code	Dimension group	Permissible Values										Coupling parameters			
		BR	L ₁	L ₃	T _{KN} ³⁾	T _{Kmax1} ³⁾	T _{KW}	P _{KV30} ²⁾	n _{Kmax} ²⁾⁴⁾	ΔK _A ²⁾	ΔK _R ²⁾	ΔK _W ²⁾	C _{Adyn} ¹⁾²⁾	C _{Rdyn} ¹⁾²⁾	C _{Tdyn} ¹⁾²⁾
	[-]	Total length	Free Length	Nominal Torque	Max. Torque ¹	Vibratory Torque	Power Loss	Rotational Speed	Axial Coupling Displacement	Radial Coupling Displacement	Angular Coupling Displacement	Dynamic axial stiffness	Dynamic radial Stiffness	Dynamic torsional stiffness	Relative Damping
		[mm]	[mm]	[kNm]	[kNm]	[kNm]	[kW]	[1/min]	[mm]	[mm]	[deg]	[N/mm]	[N/mm]	[kNm/rad]	[-]
N 070	MEDIUM	1.500	1.314	1,75	2,60	0,40	0,435	2.670	2,80	19,40	0,85	600	2,90	6,80	0,05
N 090	MEDIUM	1.500	1.310	3,70	5,60	0,90	0,530	2.780	3,60	15,10	0,85	771	8,00	18,80	0,05
N 110	MEDIUM	1.500	1.300	6,80	10,20	1,70	0,618	2.890	4,40	12,20	0,85	943	18,30	42,20	0,05
N 140	MEDIUM	1.500	1.236	14,00	21,00	3,50	0,712	3.180	5,60	9,10	0,85	1.200	55,90	116,50	0,05
N 070	MEDIUM	2.000	1.814	1,75	2,60	0,40	0,600	1.810	2,80	26,80	0,85	600	1,10	5,00	0,05
N 090	MEDIUM	2.000	1.810	3,70	5,60	0,90	0,733	1.890	3,60	20,80	0,85	771	3,00	13,60	0,05
N 110	MEDIUM	2.000	1.800	6,80	10,20	1,70	0,855	1.960	4,40	17,00	0,85	943	6,90	30,50	0,05
N 140	MEDIUM	2.000	1.736	14,00	21,00	3,50	1,000	2.120	5,60	12,80	0,85	1.200	20,20	82,90	0,05

See explanation of the technical data.

- 1) Material-related tolerances of +/- 15 % possible
- 2) Permissible values or coupling parameters depending on length
- 3) Values valid for the preferred direction of rotation (see product code)
- 4) Higher values on request

Siehe Erläuterung der Technischen Daten.

- 1) Materialbedingte Toleranzen von +/- 15 % möglich
- 2) Zulässige Werte bzw. Kupplungskennwerte längenabhängig
- 3) Werte gültig für die Vorzugsdrehrichtung (siehe Produktcode)
- 4) Höhere Werte auf Anfrage

N-FLEX[®] COMPACT 5000



GEOMETRIC DATA GEOMETRISCHE DATEN

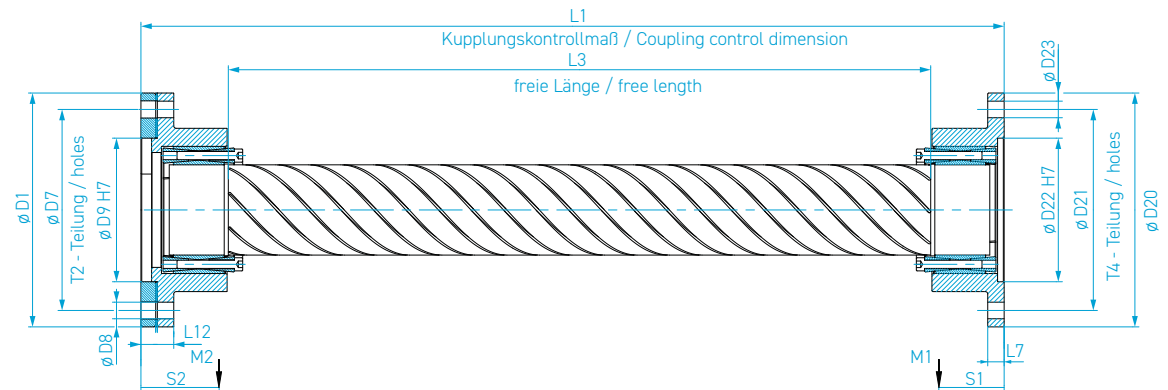

Dimension group COMPACT Baugruppe COMPACT

Size code	Dimension																		Mass moments of inertia		Mass		Distance to center of gravity	
	D ₁	D ₇	D ₈	D ₉	D ₂₀	D ₂₁	D ₂₂	D ₂₃	L ₁	L ₁	L ₃	L ₃	L ₇	L ₁₂	T ₂	T ₄	J ₁	J ₂	m ₁	m ₂	S ₁	S ₂		
	[mm]	[mm]	[mm]	[mm]	[mm]	[mm]	[mm]	[mm]	[mm]	[mm]	[mm]	[mm]	[mm]	[mm]	Pitch	Pitch	[mm]	[mm]	[kg]	[kg]	[mm]	[mm]		
N 070	190,0	155,5	14,2	110,0	180,0	155,5	115,0	14,2	1.000,0	396,0	2.052,0	814,0	210,0	1.866,0	12,0	32,0	8,0	8,0	0,020	0,040	8,4	11,6	86,5	80,2
N 090	260,0	218,0	18,2	140,0	250,0	218,0	140,0	18,2	1.000,0	460,0	2.052,0	810,0	270,0	1.862,0	18,0	38,0	8,0	8,0	0,100	0,160	18,0	23,9	74,3	72,4
N 110	285,0	245,0	20,2	175,0	285,0	245,0	175,0	20,2	1.000,0	530,0	2.052,0	800,0	330,0	1.852,0	20,0	40,0	8,0	8,0	0,170	0,260	23,6	30,4	76,6	78,8
N 140	360,0	310,0	22,2	220,0	350,0	310,0	220,0	22,2	1.000,0	684,0	2.052,0	736,0	420,0	1.764,0	25,0	45,0	10,0	10,0	-	-	-	-	-	-

N-FLEX® MEDIUM 5000



GEOMETRIC DATA GEOMETRISCHE DATEN

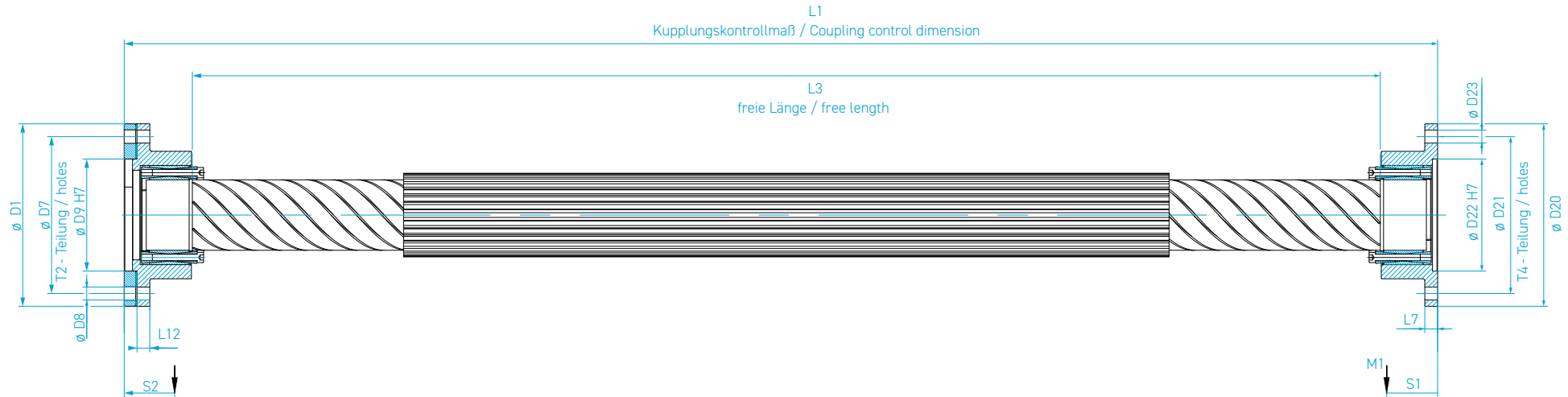

Dimension group MEDIUM Baugruppe MEDIUM

Size code	Dimension																		Mass moments of inertia		Mass		Distance to center of gravity	
	D_1	D_7	D_8	D_9	D_{20}	D_{21}	D_{22}	D_{23}	L_1	L_1	L_3	L_3	L_7	L_{12}	T_2	T_4	J_1	J_2	m_1	m_2	S_1	S_2		
	[mm]	[mm]	[mm]	[mm]	[mm]	[mm]	[mm]	[mm]	[mm]	[mm]	[mm]	[mm]	[mm]	[mm]	Pitch	Pitch	[mm]	[mm]	[kg]	[kg]	[mm]	[mm]		
N 070	190,0	155,5	14,2	110,0	180,0	155,5	115,0	14,2	2.000,0	816,0	2.052,0	1.814,0	630,0	1.866,0	12,0	32,0	8,0	8,0	0,020	0,040	8,4	11,6	86,5	80,2
N 090	260,0	218,0	18,2	140,0	250,0	218,0	140,0	18,2	2.000,0	1.000,0	2.052,0	1.810,0	810,0	1.862,0	18,0	38,0	8,0	8,0	0,100	0,160	18,0	23,9	74,3	72,4
N 110	285,0	245,0	20,2	175,0	285,0	245,0	175,0	20,2	2.000,0	1.190,0	2.052,0	1.800,0	990,0	1.852,0	20,0	40,0	8,0	8,0	0,170	0,260	23,6	30,4	76,6	78,8
N 140	360,0	310,0	22,2	220,0	350,0	310,0	220,0	22,2	2.000,0	1.548,0	2.052,0	1.736,0	1.260,0	1.764,0	25,0	45,0	10,0	10,0	-	-	-	-	-	-

N-FLEX[®] COMPACT 5001



GEOMETRIC DATA GEOMETRISCHE DATEN

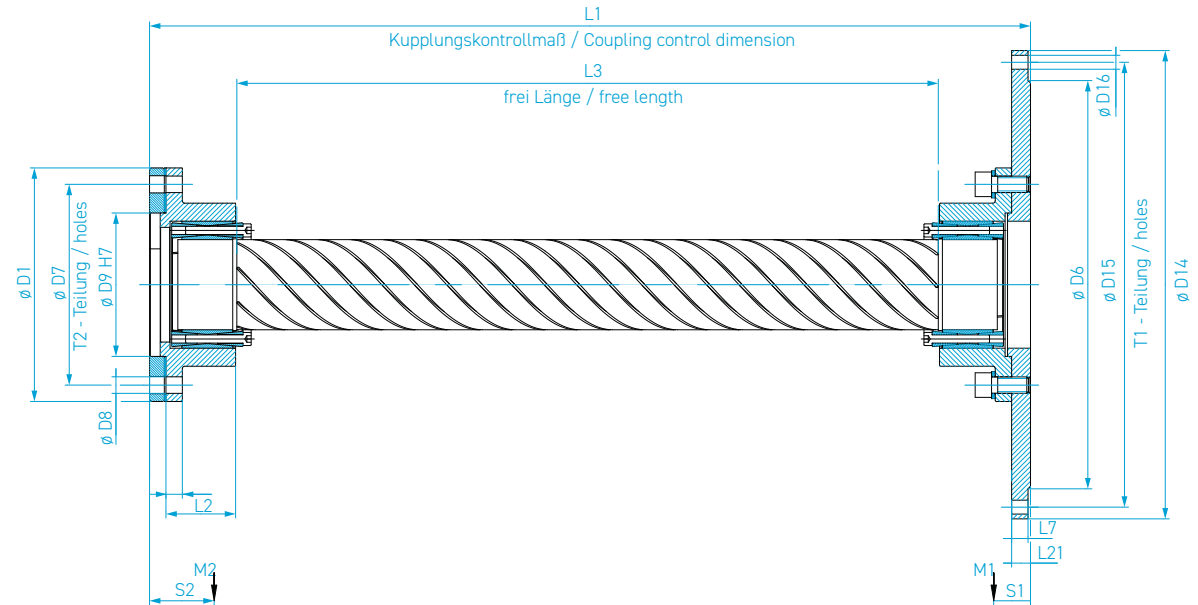

Dimension group COMPACT Baugruppe COMPACT

Size code	Dimension																			Mass moments of inertia		Mass		Distance to center of gravity		
	D ₁	D ₆	D ₇	D ₈	D ₉	D ₁₄	D ₁₅	D ₁₆	L ₁	L ₁	L ₂	L ₃	L ₃	L ₇	L ₁₂	L ₂₁	T ₁	T ₂	J ₁	J ₂	m ₁	m ₂	S ₁	S ₂		
	[mm]	[mm]	[mm]	[mm]	[mm]	[mm]	[mm]	[mm]	[mm]	[mm]	[mm]	[mm]	[mm]	[mm]	[mm]	[mm]	Pitch	Pitch	[kgm ²]	[kgm ²]	[kg]	[kg]	[mm]	[mm]		
N 070	190,0	314,5	155,5	14,2	110,0	352,4	333,4	11,0	1.000,0	406,0	2.062,0	88,0	804,0	210,0	1.866,0	10,0	12,0	15,0	8,0	8,0	0,180	0,040	18,6	11,6	50,9	80,2
N 090	260,0	409,4	218,0	18,2	140,0	466,7	438,2	13,0	1.000,0	475,0	2.067,0	85,0	795,0	270,0	1.862,0	15,0	18,0	19,0	8,0	8,0	0,730	0,160	41,2	23,6	47,1	72,4
N 110	285,0	498,2	245,0	20,2	175,0	571,5	542,9	17,0	1.000,0	550,0	2.072,0	85,0	780,0	330,0	1.852,0	20,0	20,0	23,0	6,0	8,0	1,950	0,260	66,3	30,4	44,9	78,8
N 140	360,0	584,2	310,0	22,2	220,0	673,1	641,4	17,0	1.000,0	704,0	2.072,0	105,0	716,0	420,0	1.764,0	20,0	25,0	23,0	12,0	12,0	-	-	-	-	-	-

N-FLEX® MEDIUM 5001



GEOMETRIC DATA GEOMETRISCHE DATEN

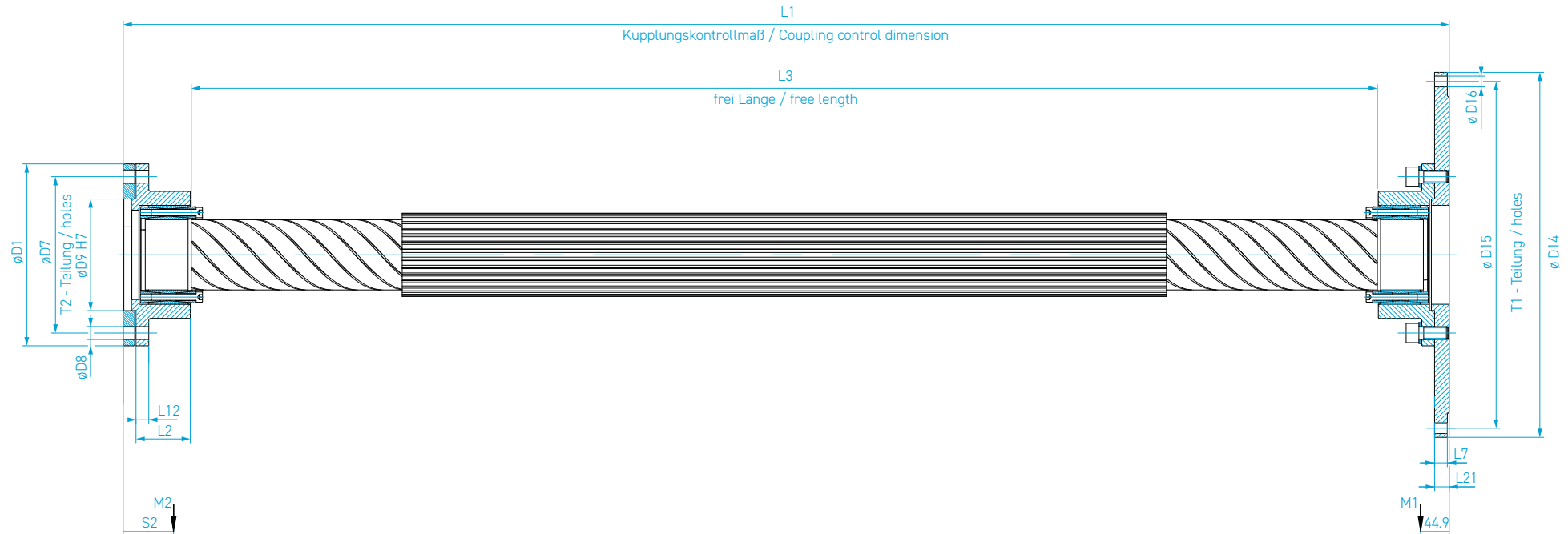

Dimension group MEDIUM Baugruppe MEDIUM

Size code	Dimension																		Mass moments of inertia		Mass		Distance to center of gravity			
	D ₁	D ₆	D ₇	D ₈	D ₉	D ₁₄	D ₁₅	D ₁₆	L ₁	L ₁	L ₂	L ₃	L ₃	L ₇	L ₁₂	L ₂₁	T ₁	T ₂	J ₁	J ₂	m ₁	m ₂	S ₁	S ₂		
	[mm]	[mm]	[mm]	[mm]	[mm]	[mm]	[mm]	[mm]	[mm]	[mm] Min.	[mm] Max.	[mm]	[mm]	[mm] Min.	[mm] Max.	[mm]	[mm]	[mm]	Pitch	Pitch	[kgm ²]	[kgm ²]	[kg]	[kg]	[mm]	[mm]
N 070	190,0	314,5	155,5	14,2	110,0	352,4	333,4	11,0	2.000,0	826,0	2.062,0	88,0	1.804,0	630,0	1.866,0	10,0	12,0	15,0	8,0	8,0	0,180	0,040	18,6	11,6	50,9	80,2
N 090	260,0	409,4	218,0	18,2	140,0	466,7	438,2	13,0	2.000,0	1.015,0	2.067,0	85,0	1.795,0	810,0	1.862,0	15,0	18,0	19,0	8,0	8,0	0,730	0,160	41,2	23,6	47,1	72,4
N 110	285,0	498,2	245,0	20,2	175,0	571,5	542,9	17,0	2.000,0	1.210,0	2.072,0	85,0	1.780,0	990,0	1.852,0	20,0	20,0	23,0	6,0	8,0	1,950	0,260	66,3	30,4	44,9	78,8
N 140	360,0	584,2	310,0	22,2	220,0	673,1	641,4	17,0	2.000,0	1.544,0	2.072,0	105,0	1.716,0	1.260,0	1.764,0	20,0	25,0	23,0	12,0	12,0	-	-	-	-	-	-

COMPACT

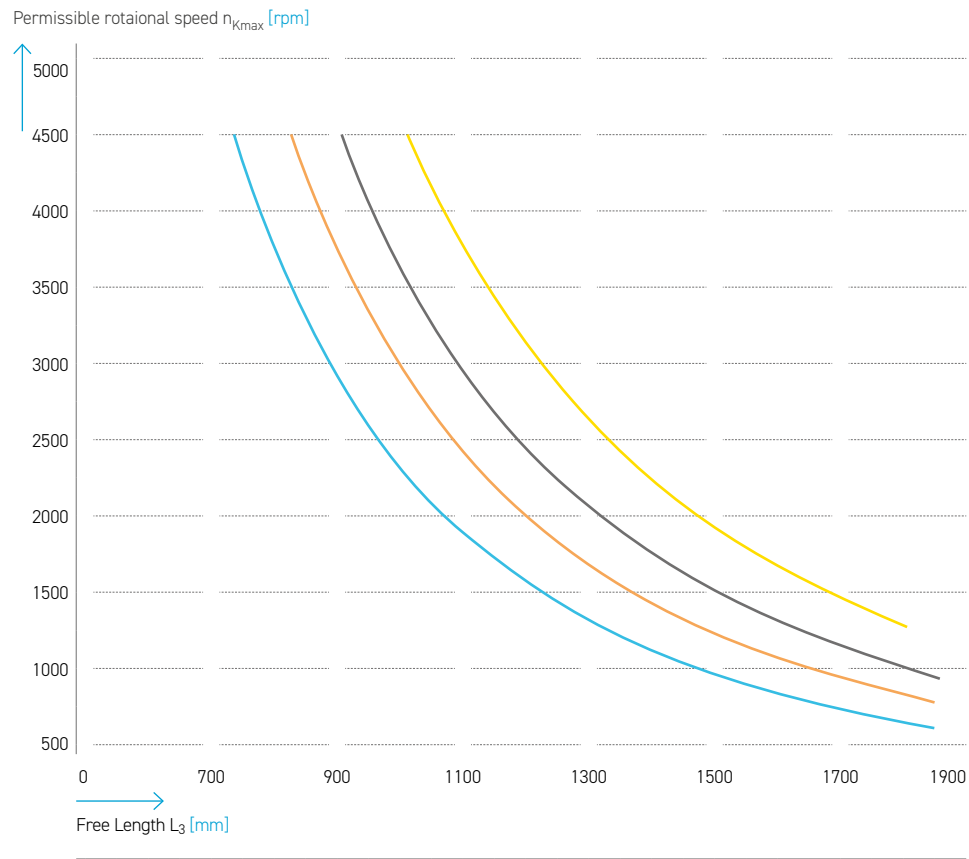

Size:
Größe

N 070
N 090
N 110
N 140

MEDIUM

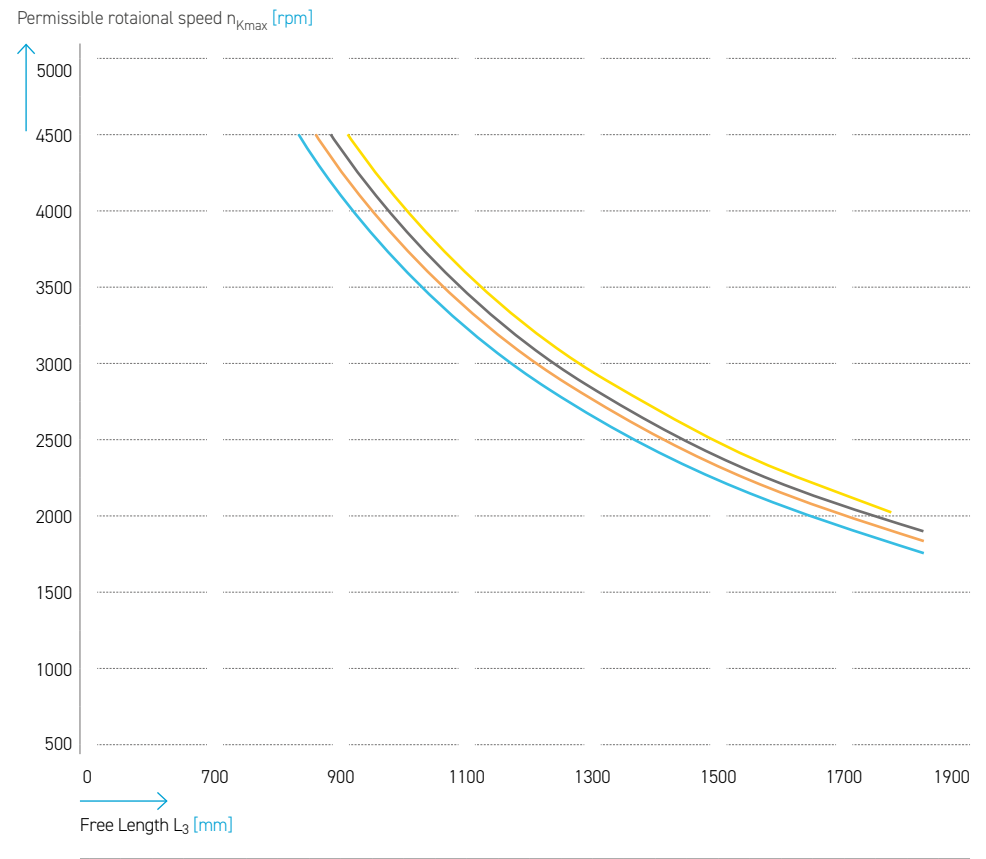

Size:
Größe

N 070
N 090
N 110
N 140

EXPLANATIONS OF THE PRODUCT CODE ERLÄUTERUNGEN DES PRODUKTCODES

All VULKAN products are identified by a product code.
This code consists of several parameters and it enables the clear identification of all products.

Alle VULKAN Produkte sind mit einem Produktcode gekennzeichnet.
Dieser Code setzt sich aus verschiedenen Parameter-Angaben zusammen und ermöglicht es, unsere Produkte eindeutig zu identifizieren.

Product Code Example Composite Shafts

We have decoded here the product code of an N-Flex® N140 for the marine industry in Medium execution, size 140 with counterclockwise direction of rotation and series 5000 with a cardan shaft connection on both sides.

Produktcode Beispiel Composite Wellen System

Wir haben hier den Produktcode einer N-Flex® N140 für die Schiffsindustrie in mittlerer Ausführung, Größe 140 mit Linkslauf und Serie 5000 mit beidseitigem Gelenkwellenanschluss entschlüsselt.

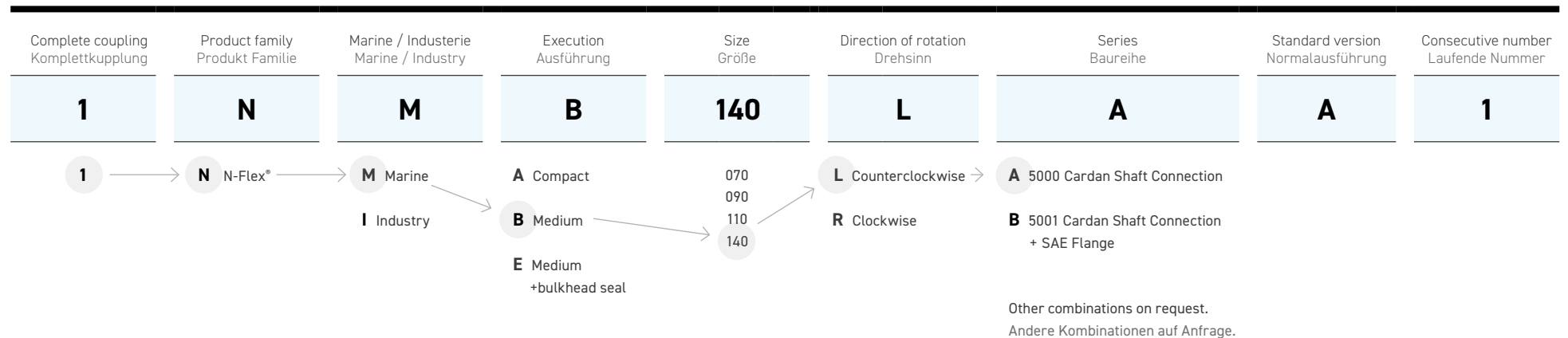

VALIDITY CLAUSE GÜLTIGKEITSKLAUSEL

The containing technical data is valid only for defined areas of applications.

These includes:

- ⊕ Main propulsion and auxiliary drives on ships
- ⊕ Generator sets on ships
- ⊕ Drives for stationary energy production with diesel or gas engines
- ⊕ All kinds of industrial drives

For other than the named applications please contact your local VULKAN supplier for further consideration.

The present catalogue shall replace all previous editions, any previous printings shall no longer be valid. Based on new developments, VULKAN reserves the right to amend and change any details contained in this catalogue respectively. The new data shall only apply with respect to couplings that were ordered after said amendment or change. It shall be the responsibility of the user to ensure that only the latest catalogue issue will be used. The respective latest issue can be seen on the website of VULKAN on www.vulkan.com.

The data contained in this catalogue refer to the technical standard as presently used by VULKAN with defined conditions according to the explanations. It shall be the sole responsibility and decision of the system administrator for the drive line to draw conclusions about the system behaviour.

VULKAN torsional vibration analysis usually only consider the pure mechanical mass-elastic system. Being a component manufacturer exclusively, VULKAN assumes no system responsibility with the analysis of the torsional vibration system (stationary, transiently)! The accuracy of the analysis depends on the exactness of the used data and the data VULKAN is provided with, respectively.

Any changes due to the technological progress are reserved. For questions or queries please contact VULKAN.

Status: 09/2024

All duplication, reprinting and translation rights are reserved. We reserve the right to modify dimensions and constructions without prior notice.

Die enthaltenen technischen Daten sind nur gültig bei Einsatz in definierten Anwendungsgebieten.

Diese umfassen:

- ⊕ Haupt- und Nebenantriebe auf Schiffen
- ⊕ Generatorsätze auf Schiffen
- ⊕ Antriebe für stationäre Energieerzeugung mit Diesel- oder Gasmotoren
- ⊕ Alle Arten industrieller Antriebe

Abweichende Anwendungen bedürfen einer individuellen Betrachtung. Bitte kontaktieren Sie hierzu ihren lokalen VULKAN Vertreter.

Die vorliegende Broschüre ersetzt alle vorherigen Ausgaben, ältere Drucke verlieren ihre Gültigkeit. VULKAN ist berechtigt, aufgrund neuerer Entwicklungen die in dieser Broschüre enthaltenen Daten entsprechend anzupassen und zu verändern. Die neuen Daten gelten nur für nach der Änderung bestellte Kupplungen. Es liegt im Verantwortungsbereich des Anwenders dafür zu sorgen, dass ausschließlich die aktuelle Katalogversion verwendet wird. Der jeweils aktuelle Stand ist auf der Webseite von VULKAN unter www.vulkan.com jederzeit abrufbar.

Die Angaben in dieser Broschüre beziehen sich auf den technischen Standard gültig im Hause VULKAN und stehen unter den in den Erläuterungen definierten Bedingungen. Es liegt allein im Entscheidungs- und Verantwortungsrahmen des Systemverantwortlichen für die Antriebslinie, entsprechende Rückschlüsse auf das Systemverhalten zu ziehen.

VULKAN Drehschwingungsanalysen berücksichtigen in der Regel nur das rein mechanische Schwingungssystem. Als reiner Komponentenhersteller übernimmt VULKAN mit der Analyse des Drehschwingungssystems (stationär, transient) nicht die Systemverantwortung! Die Genauigkeit der Analyse hängt von der Genauigkeit der verwendeten bzw. der VULKAN zur Verfügung gestellten Daten ab.

Änderungen aufgrund des technischen Fortschritts sind vorbehalten. Bei Unklarheiten bzw. Rückfragen kontaktieren Sie bitte VULKAN.

Stand: 09/2024

Das Recht auf Vervielfältigung, Nachdruck und Übersetzungen behalten wir uns vor. Maß- und Konstruktionsänderungen vorbehalten.

Publisher: VULKAN Group

Concept and Design: Hackforth Holding GmbH & Co. KG . VULKAN Marketing . Heerstraße 66, 44653 Herne / Germany . E-mail: marketing@vulkan.com

Status: 09/2024. All duplication, reprinting and translation rights are reserved. Any changes due to the technological progress are reserved. For questions or queries please contact VULKAN.